

---

# IT/200

INTERFACCIA TELEFONICA  
TELEPHONE INTERFACE  
TELEFONSCHNITTSTELLE  
INTERFACE TELEPHONIQUE  
INTERFAZ TELEFONICO  
INTERFACE TELEFONICA

---

**ISTRUZIONI**

---

**INSTRUCTIONS**

---

**ANLEITUNG**

---

**INSTRUCTIONS**

---

**INSTRUCCIONES**

---

**INSTRUÇÕES**

---

ITALIANO

ENGLISH

DEUTSCH

FRANÇAIS

ESPAÑOL

PORTUGUÊS



---

# INDICE

## Istruzioni per l'installatore

Generalità .....	4
Avvertenze .....	5
Installazione .....	6
Collegamenti .....	7
Messa in funzione .....	8
Programmazione .....	9
- Configurazione di default .....	9
- Ingresso ed uscita dalle operazioni di programmazione .....	9
- Modalità segreto di conversazione .....	9
- Durata conversazione citofonica .....	10
- Modalità analogico o codificato .....	10
- Codice IT/200 in formato blocco/utente ed impostazione modo codificato .....	11
- Codice IT/200 in formato progressivo ed impostazione modo codificato .....	11
- Durata comando apriporta .....	12
- Modalità riconoscimento flash .....	12
- Intercettazione flash .....	13
- Tipo di monitor da abbinare al telefono .....	13
- Ripristino della configurazione di default .....	14
<b>Caratteristiche tecniche .....</b>	<b>15</b>
<b>Toni e ritmi .....</b>	<b>16</b>
- Toni di segnalazione .....	16
- Ritmi di chiamata .....	16

## Istruzioni per l'utente

Glossario .....	17
Funzioni .....	18
- Chiamata su linea urbana .....	18
- Risposta alle chiamate in arrivo .....	18
- Risposta a chiamata da posto esterno ed apertura della porta .....	18
- Autoinserimento su posto esterno .....	19
- Cambio interlocutore .....	19
- Chiamata portiere .....	19
- Comando ausiliario/luce scale da telefono .....	20
- Disabilitazione avviso acustico di chiamata in arrivo .....	20
- Accesso ai servizi in DTMF della compagnia telefonica .....	20
- Funzioni ottenibili con l'utilizzo del telefono <b>bpt</b> e con telefoni standard .....	21

---

# GENERALITÀ

L'interfaccia telefonica permette il collegamento di un apparecchio telefonico alla linea videocitfonica e citfonica serie 200 e serie 100, sia essa codificata o meno.

Permette l'utilizzo, oltre al telefono **bpt**, di normali apparecchi telefonici decadici o DTMF, cordless, segreteria telefonica, modem, PABX, ecc.

L'apparecchio consente anche di inviare chiamate ad un centralino di portineria di tipo analogico o digitale e di comandare l'apriporta, luci scale centralizzato, ecc.

L'apparecchio, realizzato in un contenitore DIN a 8 moduli, è composto da un circuito stampato di base e da una scheda contenente i dip-switch per la programmazione e la selezione della tipologia d'impianto.

## Funzioni base

- Accesso diretto alla linea urbana.
- Collegamento al sistema videocitfonico serie 200 con funzione di autoinserimento (se abbinato al modulo monitor).
- Collegamento al sistema videocitfonico serie 100.
- Collegamento al sistema citfonico con o senza segreto di conversazione.
- Segreto di conversazione per impianti BPT.
- Interfaccia codificata integrata.
- Comunicazione telefonica anche in mancanza di alimentazione da rete.
- Chiamata diversificata da posto esterno/linea telefonica.
- Comando apriporta.
- Comando ausiliario/luce scale.
- Chiamata portiere.
- Messa in attesa comunicazione (urbana/citfonica).
- Protezione linea telefonica.
- Programmazione dell'apparecchio mediante telefono.
- Alimentazione da rete elettrica.

---

# AVVERTENZE

Leggere attentamente le avvertenze contenute nel seguente manuale in quanto forniscono importanti indicazioni riguardanti la sicurezza d'uso, d'installazione e manutenzione.

Dopo aver tolto l'imballaggio assicurarsi dell'integrità dell'apparecchio.

Gli elementi dell'imballaggio (sacchetti in plastica, polistirolo espanso, ecc.) non devono essere lasciati alla portata dei bambini in quanto potenziali fonti di pericolo.

Lo smaltimento degli imballi deve essere effettuato nel rispetto delle norme vigenti.

L'esecuzione dell'impianto deve essere rispondente alle norme di sicurezza vigenti.

**Non far passare i cavi telefonici in percorsi comuni a quelli dei cavi elettrici.**

Installare il centralino in ambienti non polverosi, lontano da apparecchiature che possono generare disturbi elettrici di alta frequenza quali saldatrici, motori elettrici, forni a microonde, condizionatori d'aria, ecc.

E' opportuno prevedere a monte dell'alimentatore un appropriato interruttore di sezionamento e protezione.

**Prima di collegare l'apparecchio accertarsi che i dati di targa siano rispondenti a quelli della rete di distribuzione.**

Questo apparecchio dovrà essere destinato unicamente all'uso per il quale è stato espressamente concepito; qualunque uso diverso è da considerarsi improprio e pericoloso.

Il costruttore non può essere considerato responsabile per eventuali danni derivanti da usi impropri, erronei ed irragionevoli.

Prima di effettuare qualunque operazione di pulizia o di manutenzione, disinserire l'apparecchio dalla rete di alimentazione elettrica, aprendo l'interruttore dell'impianto.

In caso di guasto e/o cattivo funzionamento dell'apparecchio, scollegarlo dall'alimentazione e non manometterlo.

Per l'eventuale riparazione rivolgersi solamente ad un centro di assistenza tecnica autorizzato dal costruttore.

Il mancato rispetto di quanto sopra può compromettere la sicurezza dell'apparecchio.

L'installatore deve assicurarsi che le informazioni per l'utente, dove previste, siano presenti sugli apparecchi.

Tutti gli apparecchi costituenti l'impianto devono essere destinati esclusivamente per l'uso per cui sono stati concepiti.

# INSTALLAZIONE

L'apparecchio, realizzato in un contenitore da 8 unità basso, può essere installato senza coprimorsetti in scatole munite di guida DIN (EN 50022).

Per le dimensioni di ingombro vedere la fig. 1A.

Oppure può essere installato a parete, con coprimorsetti, utilizzando la guida DIN in dotazione.

Per le dimensioni d'ingombro vedere la fig. 1B.

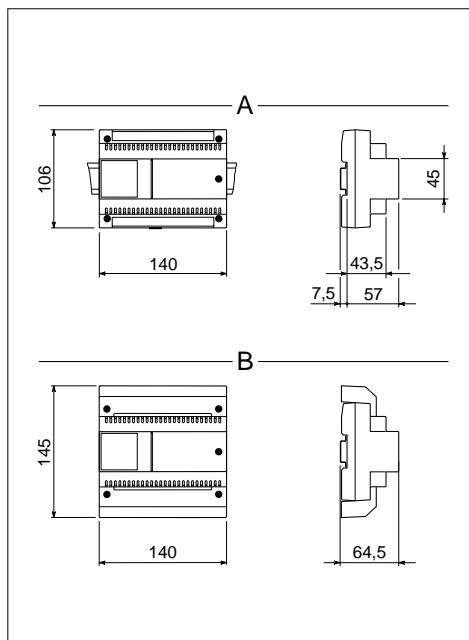

Fig. 1

# COLLEGAMENTI

Per accedere alle morsettiere togliere i coprimorsetti. Si consiglia di utilizzare, per il collegamento dei telefoni, cavo telefonico da 6/10.

Distanza massima tra interfaccia telefonica e telefono: 100 m.

**NOTA.** L'apparechio va collegato solo su linee telefoniche analogiche non su linee digitali ISDN.

## Funzione dei morsetti

### Morsettiere T (linea telefonica)

- ae linea urbana
- be linea urbana
- au telefono
- bu telefono

### Morsettiere C (dall'alimentatore)

- 5 massa
- 6 ingresso alimentazione monitor
- 7 chiamata
- 8 audio dal posto esterno
- 9 audio al posto esterno
- 12 chiamata portineria
- 22 ausiliario/luce scale

### Morsettiere M (al derivato interno)

- 5 massa
- 6 uscita alimentazione monitor
- 7 chiamata
- 8 audio dal posto esterno
- 9 audio al posto esterno

### Morsettiere A

- ~ } rete
- ~ }

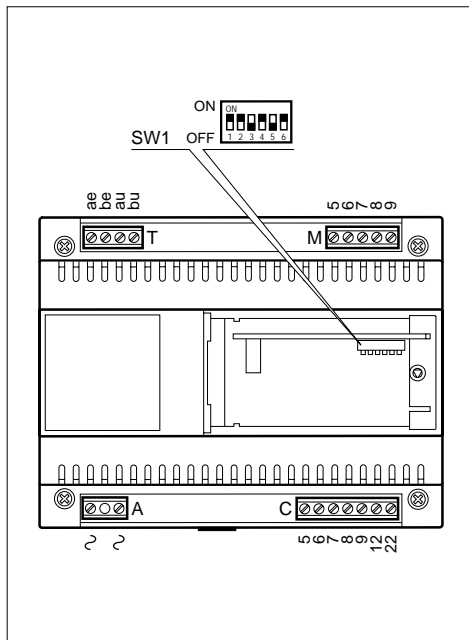

Fig. 2

# MESSA IN FUNZIONE

L'apparecchio permette il collegamento alle seguenti tipologie d'impianto BPT:

- citofonia convenzionale
- citofonia con segreto di conversazione
- videocitofonia sistema 100
- videocitofonia sistema 200
- chiamata elettronica o codificata

E' dotato di 6 dip-switch (fig. 2) da posizionare in funzione della tipologia dell'impianto (fig. 3).

Oltre all'impostazione dei dip-switch, l'ap-

parecchio deve essere anche programmato da telefono per la scelta della tipologia d'impianto (vedere il capitolo PROGRAMMAZIONE).

L'apparecchio è predisposto per essere installato in impianti **videocitofonici sistema 200**.

**ATTENZIONE.** Per impianti citofonici senza segreto di conversazione, è necessario programmare l'apparecchio secondo la modalità indicata a pag. 9.

## PREDISPOSIZIONE DIP-SWITCH

DIP-SWITCH	CITOFONIA	VIDEOCITOFONIA SISTEMA 100	VIDEOCITOFONIA SISTEMA 200
SW1	ON	ON	ON
SW2	OFF	OFF	ON
SW3	ON	OFF	ON
SW4	ON	OFF	ON
SW5	OFF	ON	OFF
SW6	ON	OFF	ON

Il ponticello **SW1** viene posizionato in OFF solo durante la procedura di PROGRAMMAZIONE.

Fig. 3



# PROGRAMMAZIONE

## Configurazione di default

- Modalità riconoscimento flash: omologato.
- Segreto di conversazione: attivo.
- Durata conversazione citofonica: 60 s.
- Durata comando apriporta: 1 s.
- Modalità: impianti con chiamata analogica.
- Codice programmato per collegamento in impianti con chiamata codificata: 80155.
- Intercettazione flash: disabilitata.
- Tipo di monitor abbinato al telefono: XV/200.

## Ingresso e uscita dalle operazioni di programmazione

Per entrare in programmazione dal telefono collegato all'interfaccia telefonica:



Assicurarsi che la cornetta sia agganciata.



Portare il dip-switch 1 in posizione OFF.

*Durante questa fase si possono effettuare una o più programmazioni consecutive.*

*L'inserimento dei codici di programmazione va eseguito durante la pausa del tono di programmazione.*

Per uscire dalla fase di programmazione:



Portare il dip-switch 1 in posizione ON.



Al termine della procedura, sollevando la cornetta o premendo il tasto viva-voce, si deve sentire il tono di libero della linea telefonica.

## Modalità segreto di conversazione



Sollevare la cornetta  
oppure



premere il tasto viva-voce.

Dopo questa operazione si deve sentire un doppio tono di invito alla programmazione.



Digitare **29**.



Digitare **0** per modalità impianto senza segreto oppure



**1** per modalità impianto con segreto.

Al termine si deve sentire un triplo tono di conferma.



Riagganciare la cornetta  
oppure



premere il tasto viva-voce.

# PROGRAMMAZIONE

## Durata conversazione citofonica



Sollevare la cornetta

oppure



premere il tasto viva-voce.

Dopo questa operazione si deve sentire un doppio tono di invito alla programmazione.

**2** **7**

Digitare **27**.



Digitare la durata della conversazione (da 10 a 99 secondi), es. 20 per 20 secondi.

Al termine si deve sentire un triplo tono di conferma.



Riagganciare la cornetta

oppure



premere il tasto viva-voce.

**NOTA.** Il tempo può essere variato solo per impianti citofonici senza segreto di conversazione (es. con A/200R).

## Modalità analogico o codificato

(vedi istruzioni allegate ai posti esterni digitali)



Sollevare la cornetta

oppure



premere il tasto viva-voce.

Dopo questa operazione si deve sentire un doppio tono di invito alla programmazione.

**6** **2**

Digitare **62**.

**0**

Digitare **0** per modalità impianto analogico (\*)  
oppure

**1**

**1** per modalità impianto codificato.

Al termine si deve sentire un triplo tono di conferma.



Riagganciare la cornetta

oppure



premere il tasto viva-voce.

**(\*)** Questa programmazione si rende necessaria solo nel caso si voglia riconfigurare l'interfaccia precedentemente programmata con codici digitali.

# PROGRAMMAZIONE

## Codice IT/200 in formato blocco/utente ed impostazione modo codificato

(vedi istruzioni allegate ai posti esterni digitali)



Solleverare la cornetta  
oppure



premere il tasto viva-voce.

Dopo questa operazione si deve sentire un doppio tono di invito alla programmazione.



Digitare **60**.



Digitare il codice di blocco (da 00 a 80), es. 39.



Digitare il codice utente (da 000 a 161), es. 052.

Al termine si deve sentire un triplo tono di conferma.



Riagganciare la cornetta  
oppure



premere il tasto viva-voce.

## Codice IT/200 in formato progressivo ed impostazione modo codificato

(vedi istruzioni allegate ai posti esterni digitali)



Solleverare la cornetta  
oppure



premere il tasto viva-voce.

Dopo questa operazione si deve sentire un doppio tono di invito alla programmazione.



Digitare **61**.



Digitare il codice utente (da 00000 a 13121), es. 01523.

Al termine si deve sentire un triplo tono di conferma.



Riagganciare la cornetta  
oppure



premere il tasto viva-voce.

# PROGRAMMAZIONE

## Durata comando apriporta



Sollevare la cornetta

oppure

premere il tasto viva-voce.



Dopo questa operazione si deve sentire un doppio tono di invito alla programmazione.



Digitare **28**.



Digitare la durata del comando apriporta (da 01 a 15 secondi), es. 06 per 6 secondi.

Al termine si deve sentire un triplo tono di conferma.



Riagganciare la cornetta

oppure

premere il tasto viva-voce.



*NOTA. È possibile sfruttare questa funzione solo con alimentatori privi di timer centralizzati (es. A/200R o VA/100.01 impostato per comando elettroserratura manuale).*

## Modalità riconoscimento flash



Sollevare la cornetta

oppure

premere il tasto viva-voce.



Dopo questa operazione si deve sentire un doppio tono di invito alla programmazione.



Digitare **20**.



Digitare **0** per riconoscimento flash omologato

oppure



**1** per riconoscimento flash lungo.

Al termine si deve sentire un triplo tono di conferma.



Riagganciare la cornetta

oppure

premere il tasto viva-voce.



# PROGRAMMAZIONE

## Intercettazione flash

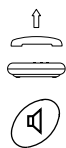

Sollevare la cornetta  
oppure  
premere il tasto viva-voce.

Dopo questa operazione si deve sentire un doppio tono di invito alla programmazione.

6 3

Digitare **63**.

0

Digitare **0** per intercettazione flash disabilitata (collegamento al telefono XT/200) oppure

1

**1** per intercettazione flash abilitata (collegamento al telefono DTMF generico).

Al termine si deve sentire un triplo tono di conferma.



Riagganciare la cornetta  
oppure  
premere il tasto viva-voce.

## Tipo di monitor da abbinare al telefono



Sollevare la cornetta  
oppure  
premere il tasto viva-voce.

Dopo questa operazione si deve sentire un doppio tono di invito alla programmazione.

6 4

Digitare **64**.

0

Digitare **0** quando viene utilizzato il monitor XV/200 o XVC/200  
oppure

1

**1** quando viene utilizzato il monitor IMT/200 o IMTC/200.

**NOTA.** In impianti con derivati interni misti digitare **1**.

Al termine si deve sentire un triplo tono di conferma.



Riagganciare la cornetta  
oppure  
premere il tasto viva-voce.

# PROGRAMMAZIONE

## Ripristino della configurazione di default



Sollevare la cornetta

oppure



premere il tasto viva-voce.

Dopo questa operazione si deve sentire un doppio tono di invito alla programmazione.



Digitare 00.

Al termine si deve sentire un triplo tono di conferma.



Riagganciare la cornetta

oppure



premere il tasto viva-voce.

---

# CARATTERISTICHE TECNICHE

- Alimentazione: 230 V ca - 50 Hz.
- Assorbimento: 6 VA max.
- Tensione di uscita: 24 V.
- Tensione di chiamata 50 V eff./50 Hz.
- Lunghezza max. dei cavi di connessione per ciascun interno: 100 m (cavo telefonico da 6/10).
- Quantità di derivati sulla stessa linea: 5 max.
- Protezione elettronica ripristinabile.
- Deviazione di frequenza: secondo le norme CCITT.
- Abilitazione monitor per la durata della conversazione.
- Durata massima conversazione citofonica: 99 s.
- Collegamento per luce scale singolo (tipo OPEN COLLECTOR 24 Vcc, 50 mA).
- Collegamento per chiamata portiere.
- Durata tempo di flash (R) programmabile.
- Durata tempo d'innesco apriporta da 1 a 15 s.
- Collegamento linea urbana anche in mancanza di alimentazione.
- Temperatura di funzionamento: da 0 °C a +35 °C.
- Umidità relativa: 90% senza condensa.
- Classe d'isolamento II.
- Dimensioni: modulo da 8 unità basso per guida DIN.
- Frequenza toni di segnalazione: 375 Hz.

L'apparecchio è omologato secondo le norme CTR 21 e soddisfa la norma EN 60950, relativa alla sicurezza elettrica, e la direttiva 89/336/EEC modificata con 93/68/EEC, relative alla compatibilità elettromagnetica.

Approvazione europea rilasciata dal  
BZT-ETS CERTIFICATION GmbH

## CE 0681 X

# TONI E RITMI

## Toni di segnalazione

ITALIANO

FUNZIONE	TEMPO (secondi)						
	0	1	2	3	4	5	6
Programmazione	■ ■		■ ■		■ ■		■ ■
Conferma di fine programmazione	■ ■ ■		■ ■ ■		■ ■ ■		■ ■ ■
Attesa	■ ■				■ ■		
Avviso	■					■	

■ = Nota    \_ = Pausa

## Ritmi di chiamata

FUNZIONE	TEMPO (secondi)						
	0	1	2	3	4	5	6
Urbana	■ ■ ■ ■					■ ■ ■ ■	
Citofonica	■ ■ ■	■ ■ ■				■ ■ ■	■ ■ ■

■ = Nota    \_ = Pausa



---

# GLOSSARIO

## Citofono

Permette di comunicare con il posto esterno e di comandare l'apertura della porta.

## Default

Con questo termine viene definita ogni predisposizione o programmazione eseguita dal fabbricante.

## Flash (R)

Premendo questo tasto dal telefono collegato si predispongono l'interfaccia a ricevere un comando (e non un numero telefonico) dalla tastiera.

## Linea urbana

Collegamento che permette di comunicare con gli utenti dell'elenco telefonico.

## Posto esterno

Permette al visitatore di effettuare la chiamata all'utente e di conversare. Se è dotato di telecamera, trasmette le immagini al videocitofono in casa.

## Telefono

Apparecchio che normalmente permette di fare e ricevere telefonate sulla linea urbana; con il centralino IT/200 il telefono può essere usato anche come citofono.

## Telefono decadico

Telefono con disco combinatore; anche alcuni telefoni a tastiera sono decadici: il telefono è decadico se, componendo un numero, alla cornetta si odono degli scatti.

## Telefono multifrequenza

Chiamato anche MF o DTMF, è il telefono più moderno. Un telefono è multifrequenza se, componendo un numero, alla cornetta si odono dei toni.

## Videocitofono

Oltre alle normali funzioni del citofono, permette di vedere sullo schermo il visitatore che chiama dal posto esterno.

# FUNZIONI

## Chiamata su linea urbana

È possibile inoltrare le chiamate nel modo abituale, come con ogni altro apparecchio.



Sollevare la cornetta

oppure



premere il tasto viva-voce.



Comporre sulla tastiera il numero desiderato.



A fine conversazione riagganciare la cornetta

oppure



premere il tasto viva-voce.

## Risposta alle chiamate in arrivo



Sollevare la cornetta

oppure



premere il tasto viva-voce.



A fine conversazione riagganciare la cornetta

oppure



premere il tasto viva-voce.

*Il telefono squilla con ritmi diversi a seconda che la chiamata provenga da una linea urbana o dal posto esterno.*

*Vedere il capitolo TONI E RITMI della suoneria.*

## Risposta a chiamata da posto esterno ed apertura della porta



Sollevare il microtelefono

oppure



premere il tasto viva-voce.



Se si desidera far entrare il chiamante premere il tasto apriporta (per telefoni **bpt**, per altri telefoni consultare la tabella riassuntiva).



Riagganciare la cornetta

oppure



premere il tasto viva-voce.

*NOTA. Se l'interfaccia è programmata con la funzione INTERCETTAZIONE FLASH disabilitata, non è possibile da un telefono standard multifrequenza, eseguire il comando quando si è in comunicazione con la linea urbana.*

# FUNZIONI

## Autoinserimento su posto esterno

È possibile attivare il posto esterno per una qualsiasi delle seguenti esigenze:

- sorvegliare l'esterno con audio e video (se il posto esterno è dotato di telecamera);
- scambiare i posti esterni;
- attivare l'apriporta.

**NOTA.** *L'autoinserimento è possibile solo con l'abbinamento del modulo video XVI/200 e ad impianto videocitofonico libero.*

## Cambio interlocutore

Questo servizio consente all'utente, in comunicazione con una linea esterna o posto esterno, di rispondere ad una chiamata proveniente dall'altra linea mettendo in attesa la comunicazione in corso.

L'interlocutore non in conversazione viene informato di questa condizione mediante tono acustico.

**NOTA.** *Durante la conversazione l'utente viene informato della chiamata in arrivo con avviso acustico.*

**Per cambiare interlocutore durante una conversazione:**



Premere il tasto di commutazione citofono/telefono (per telefoni **bpt**, per altri telefoni consultare la tabella riassuntiva).

**NOTA.** *Se l'interfaccia è programmata con la funzione INTERCETTAZIONE FLASH disabilitata, non è possibile da un telefono standard multifrequenza, eseguire il comando quando si è in comunicazione con la linea urbana.*

## Chiamata portiere



Sollevare la cornetta  
oppure



premere il tasto viva-voce.

Attendere il tono di invito alla selezione.



Premere il tasto di chiamata portiere (per telefoni **bpt**, per altri telefoni consultare la tabella riassuntiva).



A fine conversazione riagganciare la cornetta  
oppure



premere il tasto viva-voce.

**NOTA.** *Se l'interfaccia è programmata con la funzione INTERCETTAZIONE FLASH disabilitata, non è possibile da un telefono standard multifrequenza, eseguire il comando quando si è in comunicazione con la linea urbana.*

# FUNZIONI

## Comando ausiliario/luce scale da telefono

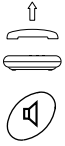

Solleverre la cornetta  
oppure  
premere il tasto viva-voce.

Attendere il tono di invito alla selezione.

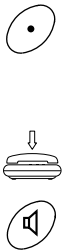

Premere il tasto ausiliario (per telefoni **bpt**, per altri telefoni consultare la tabella riassuntiva).

Riagganciare la cornetta  
oppure

premere il tasto viva-voce.

*NOTA. Se l'interfaccia è programmata con la funzione INTERCETTAZIONE FLASH disabilitata, non è possibile da un telefono DTMF, eseguire il comando quando si è in comunicazione con la linea urbana.*

*AVVERTENZA. In impianti con segreto di conversazione questo comando è disponibile solo se il derivato interno è stato chiamato dal posto esterno.*

## Disabilitazione avviso acustico di chiamata in arrivo



Digitare **R83** prima di comporre il numero telefonico.

Per tutto il tempo della conversazione il tono di avviso viene disabilitato.

Utilizzare questa funzione quando viene effettuato il collegamento con un modem.









Se si vuole ottenere in automatico la disabilitazione, aggiungere la serie di caratteri **!83**, (vedere le istruzioni del software della connessione telefonica).

## Accesso ai servizi in DTMF della compagnia telefonica

L'accesso è possibile sempre quando si è configurata l'interfaccia come INTERCETTAZIONE FLASH disabilitata, mentre è possibile solo in comunicazione con la linea urbana e in assenza di chiamate dal posto esterno citofonico, quando è configurata come INTERCETTAZIONE FLASH abilitata.

# FUNZIONI

Funzioni ottenibili con l'utilizzo del telefono **bpt**  
e con telefoni standard

	TELEFONO BPT XT/200	TELEFONO MULTIFREQUENZA	TELEFONO DECADICO
PROGRAMMAZIONE	si	si	non possibile
CHIAMATA URBANA	diretto	diretto	diretto
RICEZIONE CHIAMATE URBANE/TELEFONICHE	si	si	si
ACCESSO AI SERVIZI TELECOM IN DTMF	si	si	non possibile
AUTOINSERIMENTO	 (XV/200)	 (XV/200)	 (XV/200)
APRIPORTA		R+85	non possibile
AUSILIARIO/LUCE SCALE CENTRALIZZATO (uscita disponibile nell'alimentatore)		R+88	non possibile
AUSILIARIO/LUCE SCALE SINGOLO (uscita disponibile nell' IT/200) (¹)		R+88	non possibile
CHIAMATA PORTIERE		R+87	non possibile
CAMBIO INTERLOCUTORE		R+80	non possibile

(¹) E' possibile utilizzare l'uscita AUSILIARIO/LUCE SCALE SINGOLO anche in impianti con LUCE SCALE CENTRALIZZATO impostando i dip-switch n° 4 e 5 in OFF.



---

# CONTENTS

## Instructions for the installer

Foreword .....	.24
Warnings .....	.25
Installation .....	.26
Connections .....	.27
Prior to operation .....	.28
Programming .....	.29
- Default settings .....	.29
- Entering and exiting the programming functions .....	.29
- Conversation privacy mode .....	.29
- Entry panel conversation length .....	.30
- Analogue or coded mode .....	.30
- IT/200 code in block/user format and coded mode setup .....	.31
- IT/200 code in progressive format and coded mode setup .....	.31
- Door lock release triggering time .....	.32
- Flash detection mode .....	.32
- Flash interception .....	.33
- Type of monitor to be combined with the telephone .....	.33
- Resetting default settings .....	.34
<b>Technical features</b> .....	<b>.35</b>
<b>Tones and frequencies</b> .....	<b>.36</b>
- Signal tones .....	.36
- Call frequencies .....	.36

## Instructions for the user

Glossary .....	.37
Functions .....	.38
- Call on local line .....	.38
- Answering incoming calls .....	.38
- Answering calls from entry panel and opening the door .....	.38
- Self-connection on entry panel .....	.39
- Interlocutor switching .....	.39
- Porter call .....	.39
- Telephone auxiliary/stair light control .....	.40
- Disabling the incoming call warning tone .....	.40
- Accessing in DTMF services of telephone company .....	.40
- Functions available using the <b>bpt</b> telephone and standard telephone sets .....	.41

---

# FOREWORD

The telephone interface enables a telephone set to be connected to the 200 series and 100 series video entry and audio entry control lines, whether coded or not.

In addition, apart from the **bpt** telephone, it enables ordinary decadic or DTMF sets, cordless phones, answering machines, modems, PABX switchboards etc. to be used.

The unit also enables calls to be sent to an analogue or digital porter switchboard and to control the door lock release, centralized stair light functions, etc.

The unit, housed in a 8 DIN module receptacle, is made up of a main printed circuit and a board containing the dip-switches for programming and selecting the system type.

## Basic functions

- Direct access to the local telephone line.
- Connection to the series 200 video entry control system with self-connection function (where combined with the monitor module).
- Connection to the 100 series video entry control system.
- Connection to the audio entry control system with or without conversation privacy.
- Conversation privacy for BPT installations.
- Integrated coded interface.
- Telephone communication even during power outages.
- Different call tone for entry panel/telephone calls.
- Door lock release control.
- Auxiliary/stair light control.
- Porter call.
- Hold (telephone/entry panel call).
- Telephone line protection.
- Programming of the unit using telephone set.
- Mains power supply.



---

# WARNINGS

Read the warnings contained herein carefully as they provide important instructions for safe operation, installation and maintenance.

Having removed the packaging, make sure the unit is intact.

The packaging materials (plastic bags, foam polystyrene, etc.) must be kept out of the reach of children as they represent potential sources of danger.

The material must be disposed of according to the laws in force.

The installation of the system must comply with the safety rules in force.

**Do not run telephone cables in the same raceways as electrical cables.**

Install the unit in a fairly dust-free room, away from units liable to generate high-frequency electrical noise such as welding machines, electric motors, microwave ovens, air conditioners, etc.

It is advisable to install a suitable cutout and safety device upstream of the power supplier.

Before connecting up the unit, make sure the data on the rating plate correspond to the mains power supply.

This unit must be used only for the use for which it was explicitly designed; any other use shall be considered improper and hazardous.

The manufacturer cannot be held responsible for any damage as a result of improper, incorrect and unreasonable use.

Before cleaning or doing any maintenance work on the unit, disconnect it from the mains power supply by opening the system's switch.

In the event the unit is faulty and/or operates poorly, disconnect it from the power supply and do not tamper with it.

When in need of repair work, contact only technical servicing centres authorized by the manufacturer.

Failure to comply with the above provisions may compromise the safety of the unit.

The installer must make sure that the user information, where applicable, is to be found on the unit.

All the equipment making up the system must be used only for the user for which they were designed.

# INSTALLATION

The unit, housed in a low profile module of 8 DIN units, can be installed without terminal covers in cabinets featuring DIN guides (EN 50022).

See fig. 1A for the overall dimensions.

Alternatively, it can be wall mounted, using the DIN guide supplied, and in this case will require terminal covers.

See fig. 1B for the overall dimensions.

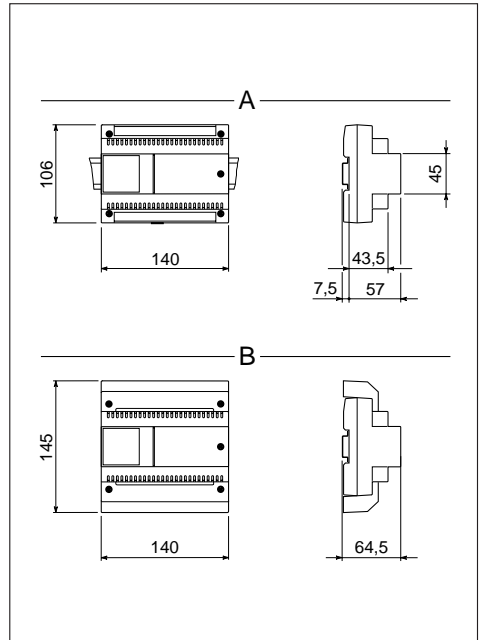

Fig. 1

# CONNECTIONS

In order to access the terminals, remove the terminal covers. The use of a 6/10 telephone cable is recommended for connecting the telephones.

The maximum distance between the telephone interface and the telephone is 100 m.

**NOTE.** The unit must be connected on analogue telephone lines only and not digital ISDN lines.

## Functions of each terminal

### Terminal block T (telephone line)

- ae local line
- be local line
- au telephone
- bu telephone

### Terminal block C (from power supplier)

- 5 earth
- 6 monitor power supply input
- 7 call
- 8 audio from entry panel
- 9 audio to entry panel
- 12 porter call
- 22 auxiliary/stair light

### Terminal block M (to receiver)

- 5 earth
- 6 monitor power supply output
- 7 call
- 8 audio from entry panel
- 9 audio to entry panel

### Terminal block A

- ~ } mains
- ~ }

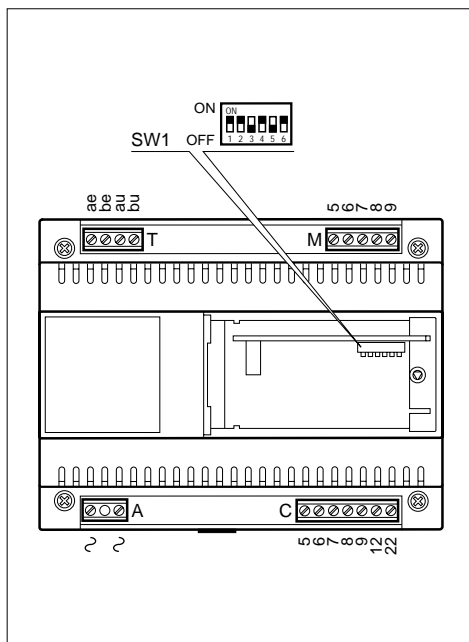

Fig. 2

# PRIOR TO OPERATION

The unit enables connections to the following BPT system types:

- conventional audio entry control system
- audio entry control system with conversation privacy
- system 100 video entry control system
- system 200 video entry control system
- electronic or coded call

It features 6 dip-switches (fig. 2) whose settings depend on the type of system (fig. 3). Apart from the setting of the dip-switches,

the unit must also be programmed using the telephone to set the system type (see section entitled PROGRAMMING).

The unit is designed to be installed in **system 200 video entry control systems.**

**IMPORTANT INSTALLER NOTE.** *When setting up for audio system 200, in addition to setting the dip-switches as shown above, carry out the programming shown overleaf for Conversation Privacy and set for 0 mode (see page 29).*

## DIP-SWITCH SETTINGS

DIP-SWITCH	AUDIO SYSTEM	VIDEO SYSTEM 100	VIDEO SYSTEM 200
SW1	ON	ON	ON
SW2	OFF	OFF	ON
SW3	ON	OFF	ON
SW4	ON	OFF	ON
SW5	OFF	ON	OFF
SW6	ON	OFF	ON

The jumper SW1 is only set to OFF during the PROGRAMMING procedure.

Fig. 3

# PROGRAMMING

## Default settings

- Flash detection mode: type approved.
- Conversation privacy: on.
- Conversation length: 60 s.
- Door lock release triggering time: 1 s.
- Mode: systems with analogue call.
- Programmed code for connection in systems with coded call: 80155.
- Flash interception: disabled.
- Type of monitor combined with the telephone: XV/200.

## Entering and exiting the programming functions

In order to enter programming mode via the telephone connected to the telephone interface:



Make sure the receiver is hung up.



Set dip-switch 1 to OFF.

*During this phase, one or more programming procedures can be carried out in a row.*

*The programming codes must be entered during the pause in the programming tone.*

In order to exit programming mode:



Set dip-switch 1 to ON.



Once finished, when the receiver is lifted or hands-free button pressed, the dial tone must be heard.

## Conversation privacy mode



Lift the receiver

or



press the hands-free key.

Following this operation, a double tone should sound, prompting you to commence programming.



Key in 29.



Press 0 for the no-privacy mode

or



1 for the privacy mode.

Once finished, you should hear a triple tone confirming the setting.



Replace the receiver

or



press the hands-free key.

# PROGRAMMING

## Entry panel conversation length



Lift the receiver

or



press the hands-free key.

Following this operation, a double tone should sound, prompting you to commence programming.



Key in 27.



Key in conversation length (in the range 10 to 99 seconds), e.g. 20 for 20 seconds.

Once finished, you should hear a triple tone confirming the setting.



Replace the receiver

or



press the hands-free key.

**NOTE.** *The time can only be varied for audio entry control systems without conversation privacy (e.g. with A/200R).*

## Analogue or coded mode

(see instructions attached to the digital entry panels)



Lift the receiver

or



press the hands-free key.

Following this operation, a double tone should sound, prompting you to commence programming.



Key in 62.



Press 0 for analogue mode (\*)

or



1 for coded mode.

Once finished, you should hear a triple tone confirming the setting.



Replace the receiver

or



press the hands-free key.

*(\*) This programming procedure is only necessary in the event you wish to reconfigure the interface previously programmed with digital codes.*

# PROGRAMMING

## IT/200 code in block/user format and coded mode setup

(see instructions attached to the digital entry panels)



Lift the receiver

or



press the hands-free key.

Following this operation, a double tone should sound, prompting you to commence programming.



Key in 60.



Key in the block code (in the range 00 to 80), e.g. 39.



Key in the user code (in the range 000 to 161), e.g. 052.

Once finished, you should hear a triple tone confirming the setting.



Replace the receiver

or



press the hands-free key.

## IT/200 code in progressive format and coded mode setup

(see instructions attached to the digital entry panels)



Lift the receiver

or



press the hands-free key.

Following this operation, a double tone should sound, prompting you to commence programming.



Key in 61.



Key in the user code (in the range 00000 to 13121), e.g. 01523.

Once finished, you should hear a triple tone confirming the setting.



Replace the receiver

or



press the hands-free key.

# PROGRAMMING

## Door lock release triggering time



Lift the receiver  
or  
press the hands-free key.



Following this operation, a double tone should sound, prompting you to commence programming.



Key in 28.



Key in the door lock release triggering time (in the range 01 to 15 seconds), e.g. 06 for 6 seconds.

Once finished, you should hear a triple tone confirming the setting.



Replace the receiver  
or  
press the hands-free key.



**NOTE.** This function can only be used with power suppliers with no centralized timers (e.g. A/200R or VA/100.01 set for manual solenoid lock release control).

## Flash detection mode



Lift the receiver  
or  
press the hands-free key.



Following this operation, a double tone should sound, prompting you to commence programming.

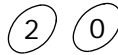

Key in 20.



Press 0 for type approved flash detection

or



1 for long flash detection.

Once finished, you should hear a triple tone confirming the setting.



Replace the receiver  
or  
press the hands-free key.





# PROGRAMMING

## Flash interception



Lift the receiver

or



press the hands-free key.

Following this operation, a double tone should sound, prompting you to commence programming.



Key in **63**.



Press **0** to disable flash interception (connection to XT/200 telephone)

or



**1** to enable flash interception (connection to generic DTMF telephone).

Once finished, you should hear a triple tone confirming the setting.



Replace the receiver

or



press the hands-free key.

## Type of monitor to be combined with the telephone



Lift the receiver

or



press the hands-free key.

Following this operation, a double tone should sound, prompting you to commence programming.



Key in **64**.



Press **0** when using XV/200 or XVC/200 monitor

or



**1** when using IMT/200 or IMTC/200 monitor.

**NOTE.** In systems with mixed extensions, press **1**.

Once finished, you should hear a triple tone confirming the setting.



Replace the receiver

or



press the hands-free key.

---

# PROGRAMMING

## Resetting default settings



Lift the receiver

or



press the hands-free key.

Following this operation, a double tone should sound, prompting you to commence programming.



Key in 00.

Once finished, you should hear a triple tone confirming the setting.



Replace the receiver

or



press the hands-free key.

---

# TECHNICAL FEATURES

- Supply voltage: 230 V AC 50 Hz.
- Current demand: 6 VA max.
- Voltage output: 24 V.
- Call voltage active 50 V/50 Hz.
- Max. length of connecting cables for each extension: 100 m (6/10 telephone cable).
- Amount of extensions on the same line: 5 max.
- Reprimable electronic safety device.
- Frequency deviation: according to CCITT standards.
- Monitor enabling for the duration of the conversation.
- Maximum entry panel conversation length: 99 s.
- Connection for single stair light (OPEN COLLECTOR type 24 V DC, 50 mA).
- Connection for porter call.
- Programmable flash (R) length.
- Door lock release triggering time in the range 1 to 15 s.
- Local line connection even during power outages.
- Working temperature range: from 0 °C to +35 °C.
- Relative humidity: 90% with no condensation.
- Insulation rating: II.
- Dimensions: 8 DIN units module.
- Signal tone frequency: 375 Hz.

The unit is type approved according to standard CTR 21 and meets the requirements of the EN 60950 standard relating to electrical safety, and of the 89/336/EEC directive amended with 93/68/EEC directive relating to electromagnetic compatibility.

European approval issued by  
BZT-ETS CERTIFICATION GmbH

## CE 0681 X

# TONES AND FREQUENCIES

## Signal tones

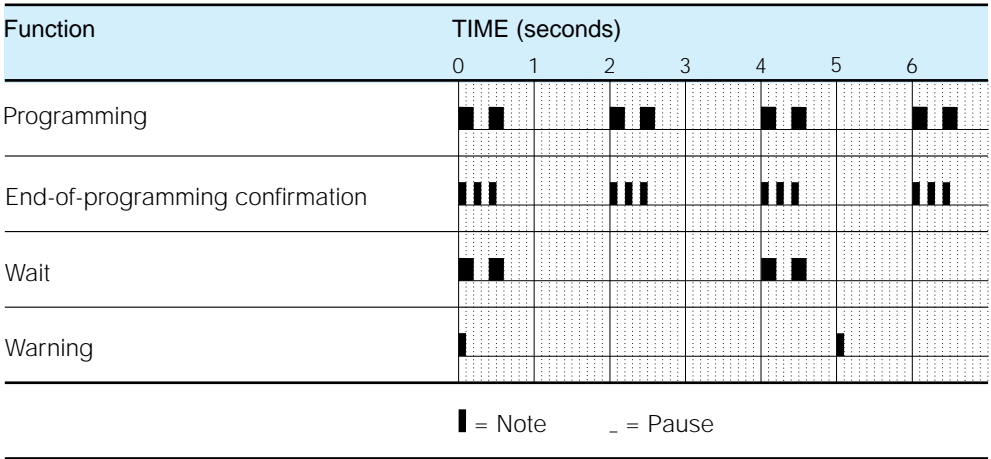

## Call frequencies

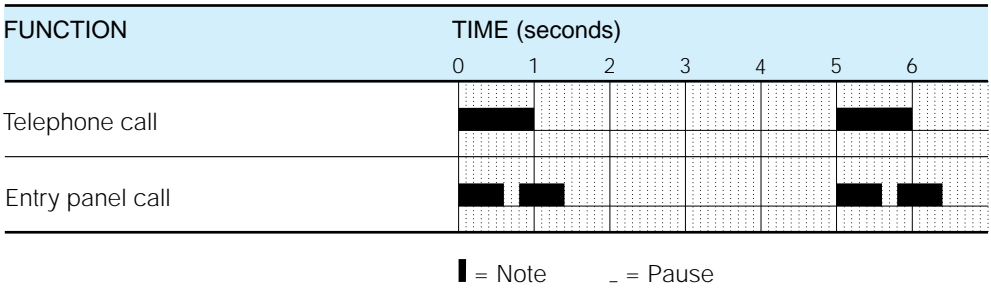

---

# GLOSSARY

## Handset

Enables the user to talk with the entry panel and release the door lock.

## Default

This term is used to define any settings or programming performed by the manufacturer.

## Flash (R)

When this button on the connected telephone is pressed, the interface stands by to receive a command (and not a telephone number) via the push-buttons.

## Local line

Connection which enables communication with the other users on the telephone network.

## Entry panel

Enables the visitor to call the occupant and talk with him/her.  
Where it features a camera, the images are sent to the video entry handset in the home.

## Telephone

Unit which normally enables telephone calls to be made and received on the local line; with the IT/200 switchboard, the telephone can also be used as an audio entry handset.

## Decadic telephone

A telephone with a dial, through some push-button phones are also decadic: the telephone is decadic if you hear clicks in the receiver whilst the number is being dialled.

## Multifrequency telephone

Also known as MF or DTMF, this is the more modern type of set.  
A telephone is multifrequency if you hear tones in the receiver whilst the number is being dialled.

## Video entry handset

Apart from the normal functions of the audio entry handset, this enables the visitor calling from the entry panel to be seen on the monitor.

# FUNCTIONS

## Call on local line

Calls can be made in the usual way, just as though you were using a normal telephone.



Lift the receiver

or



press the hands-free key.



Dial the desired number.



Once the conversation is over, replace the receiver

or



press the hands-free key.

## Answering incoming calls



Lift the receiver

or



press the hands-free key.



Once the conversation is over, replace the receiver

or



press the hands-free key.

*The telephone rings with different frequencies depending on whether the call is a telephone call or whether it is from the entry panel.*

*See section entitled TONES AND FREQUENCIES.*

## Answering calls from entry panel and opening the door



Lift the receiver

or



press the hands-free key.



If you want to let the caller in, press the door lock release button (in the case of **bpt** telephones; for other telephones, consult the summary table).



Replace the receiver

or



press the hands-free key.

***NOTE.** If the interface is programmed with the FLASH INTERCEPTION function disabled, the control will not work using a standard multifrequency set whilst communication on the local telephone line.*

# FUNCTIONS

## Self-connection on entry panel

The entry panel can be activated for any of the following needs:

- audio and video monitoring of the entrance (where the entry panel features a camera);
- exchanging entry panels;
- releasing door lock.

**NOTE.** *Self-connection is only possible when the set is combined with the video module XV/200 and when the video entry system is not engaged.*

## Interlocutor switching

This function enables the user, whilst communicating with an outside line or the entry panel, to answer a call on the other line, putting the current conversation on hold.

The interlocutor put on hold hears a tone advising him/her of the current hold status.

**NOTE.** *During the conversation, a sound advise the user of the incoming call.*

**In order to switch between interlocutors during a conversation:**



Press the entry handset/telephone transfer key (in the case of **bpt** telephones; for other telephones, consult the summary table).

**NOTE.** *If the interface is programmed with the FLASH INTERCEPTION function disabled, the control will not work using a standard multifrequency set whilst communicating on the local telephone line.*

## Porter call



Lift the receiver

or



press the hands-free key.

Wait for the dial tone.



Press the porter call key (in the case of **bpt** telephones; for other telephones, consult the summary table).



Once the conversation is over, replace the receiver

or



press the hands-free key.

**NOTE.** *If the interface is programmed with the FLASH INTERCEPTION function disabled, the control will not work using a standard multifrequency set whilst communicating on the local telephone line.*

# FUNCTIONS

## Telephone auxiliary/stair light control



Lift the receiver  
or



press the hands-free key.

Wait for the dial tone.



Press the auxiliary key (in the case of **bpt** telephones; for other telephones, consult the summary table).



Replace the receiver  
or



press the hands-free key.

**NOTE.** *If the interface is programmed with the FLASH INTERCEPTION function disabled, the control will not work using a DTMF set whilst communicating on the local telephone line.*

**WARNING.** *In installations featuring conversation privacy, this control is only available if the extension has been called from the entry panel.*

## Disabling the incoming call warning tone



Key in **R83** before dialling the telephone number.

The warning tone will remain disabled for the entire duration of the call.

Use this function when a modem connection is made. If you want the disabling to be automatic, add the series of digits **!83**, (see the software instructions for the telephone connection).









## Accessing in DTMF services of telephone company

Access is always possible when the interface's FLASH INTERCEPTION is disabled, whilst it is only possible during communication with the local telephone line, with no incoming call from the entry panel, when the FLASH INTERCEPTION is enabled.



# FUNCTIONS

## Functions available using the **bpt** telephone and standard telephone sets

	BPT XT/200 TELEPHONE	MULTIFREQUENCY TELEPHONE	DECADIC TELEPHONE
PROGRAMMING	yes	yes	not possible
LOCAL CALL	direct	direct	direct
RECEPTION LOCAL/TELEPHONE CALLS	yes	yes	yes
ACCESS TO DTMF SERVICES	yes	yes	not possible
SELF-CONNECTION	 (XV/200)	 (XV/200)	 (XV/200)
DOOR LOCK RELEASE		R+85	not possible
AUX./CENTRALIZED STAIR LIGHT (output available in power supplier)		R+88	not possible
AUX./SINGLE STAIR LIGHT (output available in IT/200) (1)		R+88	not possible
PORTER CALL		R+87	not possible
INTERLOCUTOR SWITCHING		R+80	not possible

(1) The AUXILIARY/SINGLE STAIR LIGHT output can also be used in installations with AUXILIARY/CENTRALIZED STAIR LIGHT by setting dip-switches 4 and 5 to OFF.



# INHALTSVERZEICHNIS

## Installationsanleitung

Allgemeines	.44
Anmerkungen	.45
Installation	.46
Anschlüsse	.47
Inbetriebnahme	.48
Programmierung	.49
- Standardkonfiguration	.49
- Beginn und Ende der Programmiervorgänge	.49
- Betriebsart Mithörsperre	.49
- Dauer des an der Haussprechanlage geführten Gesprächs	.50
- Analoge oder codierte Modalität	.50
- Code IT/200 in Block-/Bedienerformat und codierte Moduseingabe	.51
- Code IT/200 in progressivem Format und codierte Moduseingabe	.51
- Dauer der Türöffnersteuerung	.52
- Flasherkennungsmodus	.52
- Flash-Auffangfunktion	.53
- Telefon mit Monitorkombination	.53
- Wiederherstellung der Standardkonfiguration	.54
Technische Daten	.55
Töne und Rhythmen	.56
- Signaltöne	.56
- Anrufrhythmen	.56

## Bedienungsanleitung

Glossar	.57
Funktionen	.58
- Anruf auf Ortsleitung	.58
- Beantwortung der eingehenden Anrufe	.58
- Beantwortung des Anrufs von der Außenstation und Türöffnen	.58
- Selbsteinschaltung auf der Außenstation	.59
- Wechsel des Gesprächsteilnehmers	.59
- Pförtneranruf	.59
- Steuerung der Zusatzfunktion/Treppenlicht vom Telefon aus	.60
- Ausschaltung der Tonmeldung des ankommenden Anrufs	.60
- Zugang zu den Servicefunktionen DTMF der Telefongesellschaft	.60
- Durch das <b>bpt</b> Telefon und die Standardtelefone zugängliche Funktionen	.61

---

# ALLGEMEINES

Die Telefonschnittstelle ermöglicht den Anschluß eines Telefonapparats an die codierte oder uncodierte Leitung der Video- und Haussprechanlage der Serie 200 und 100. Über die Benutzung des **bpt**-Telefons hinaus können dank dieser Schnittstelle normale IWW- oder MFV-Telefon-apparate, Handys, Anrufbeantworter, Modems, PABX, usw., benutzt werden.

Das Gerät besteht aus einer Basisplatine sind einer Zusatztaste mit den für die Programmierung notwendigen DIL-Sc halter. Des Gehäuse hat die Abmessungen von 8 DIN-Einheiten.

## Basisfunktionen

- Direktzugang zu der Amtsleitung.
- Anschluß an die Videosprechanlage der Serie 200 mit Selbsteinschaltfunktion (falls dem Monitormodul zugeordnet).
- Anschluß an die Videosprechanlage der Serie 100.
- Anschluß an die Haussprechanlage mit oder ohne Mithörsperre.
- Mithörsperre für BPT-Anlagen.
- Integrierte und codierte Schnittstelle.
- Telefongespräch auch bei fehlender Stromversorgung.
- Rufunterscheidung der Außenstation / Telefonleitung.
- Funktion Türöffner.
- Zusatzfunktion/Treppenlicht.
- Pfortneranruf.
- Warteschleife (Ortsgespräch/Gespräch mittels Haussprechanlage).
- Schutzvorrichtung der Telefonleitung.
- Programmierung der Schnittstelle durch das Telefon.
- Versorgung aus dem Stromnetz.

---

# ANMERKUNGEN

Die Anmerkungen der nachfolgenden Anleitung aufmerksam durchlesen, da sie wichtige Sicherheitshinweise über die Benutzung, Installation und Wartung liefern.

Verpackung abnehmen und sicherstellen, daß das Gerät einwandfrei ist.

Die Verpackungsteile (Plastikbeutel, Schaumpolystyrol, etc.) müssen außerhalb der Reichweite von Kindern aufbewahrt werden, da diese eine Gefahrenquelle darstellen können.

Die Verpackungsteile nicht in die Umwelt freisetzen, sondern sich an die geltenden Gesetze halten.

Der Anlagenbau muß den geltenden Sicherheitsvorschriften entsprechen.

**Telefonkabel nicht zusammen mit elektrischen Kabeln legen.**

Gerät nicht an einem staubigen Ort und fern von Geräten, die elektrische Hochfrequenzstörungen verursachen können, wie Schweißapparate, elektrische Motoren, Mikrowellenherd, Klimaanlage, etc. aufstellen.

Netzseitig ist ein Fehlerstromschalter einzusetzen.

Sich vor dem Anschluß des Apparats vergewissern, daß die Daten auf dem Schild denen des Versorgungsnetzes entsprechen.

Dieses Gerät ausschließlich für die eigens hierfür gedachte Benutzung gebrauchen; eine Zweckentfremdung ist unangebracht und somit gefährlich.

Der Hersteller übernimmt keine Haftung für eventuelle Schäden, die auf eine Zweckentfremdung, eine falsche oder unvernünftige Bedienung zurückzuführen sind. Vor jeglicher Reinigung oder Instandhaltung ist der Apparat durch die Öffnung des Anlagenschalters vom Stromnetz zu trennen.

Bei Defekten und/oder Störungen ist der Apparat von der Stromversorgung zu trennen; nicht umrüsten.

Im Falle einer Reparatur sich ausschließlich an eine vom Hersteller dazu ermächtigte Kundendienststelle wenden.

Die mangelnde Beachtung des oben Genannten kann die Sicherheit des Geräts beeinträchtigen.

Der Installateur muß sich vergewissern, daß die für den Benutzer erforderlichen Informationen auf der dafür vorgesehenen Stelle auf den Geräten vorhanden sind.

Alle Anlagengeräte dürfen ausschließlich für die hierfür gedachte Benutzung verwendet werden.

# INSTALLATION

Der Apparat, der sich in einem Gehäuse zu 8 DIN-Einheiten, flach, befindet, kann in Kästen mit DIN-Schienen (EN 50022) ohne Klemmenabdeckungen eingebaut werden. Für die Außenabmessungen siehe Abb. 1A. Auch ist die Wandmontage, mit Klemmenabdeckungen und der Benutzung der mitgelieferten DIN-Schiene möglich. Für die Außenabmessungen siehe Abb. 1B.



Abb. 1

# ANSCHLÜSSE

Klemmenabdeckungen abnehmen, um die Klemmleisten zu erreichen. Für den Telefonanschluß empfiehlt es sich, ein Telefonkabel mit einen Qüerschnitt von 0,6 mm zu verwenden.

Maximaler Abstand zwischen Telefonschnittstelle und Telefon: 100 m.

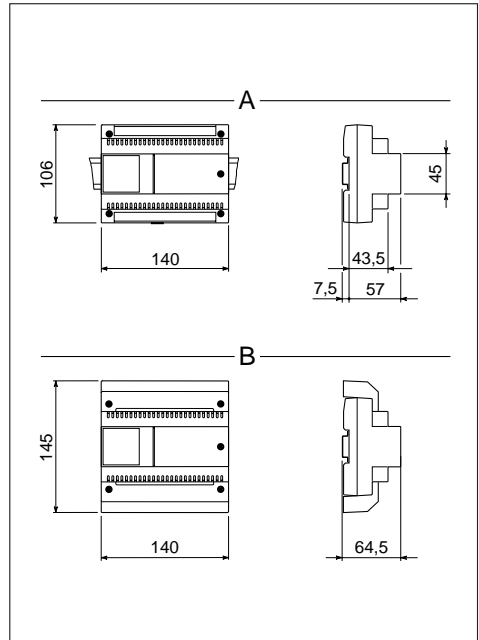
**HINWEIS.** Das Gerät darf nur an analogen und nicht an digitalen ISDN-Telefonleitungen angeschlossen werden.

## Belegung der Klemmleisten

### Klemmleiste T (Telefonleitung)

- ae Ortsleitung
- be Ortsleitung
- au Telefon
- bu Telefon

### Klemmleiste C (vom Netzgerät)

- 5 Masse
- 6 Eingang Monitorstromversorgung
- 7 Anruf
- 8 Audio von Außenstation
- 9 Audio zur Außenstation
- 12 Pfortneranruf
- 22 Zusatzfunktion/Treppenlicht

### Klemmleiste M (zur Innensprechstelle)

- 5 Masse
- 6 Ausgang Monitorstroversorgung
- 7 Anruf
- 8 Audio von Außenstation
- 9 Audio zur Außenstation

### Klemmleiste A

- ~ } Netz
- ~ }



Abb. 2

# INBETRIEBNAHME

Der Apparat ermöglicht den Anschluß an die folgenden BPT-Anlagentypen:

- herkömmliche Haussprechanlage
- Haussprechanlage mit Mithörsperre
- Videosprechanlage der Serie 100
- Videosprechanlage der Serie 200
- Elektronischer oder codierter Anruf

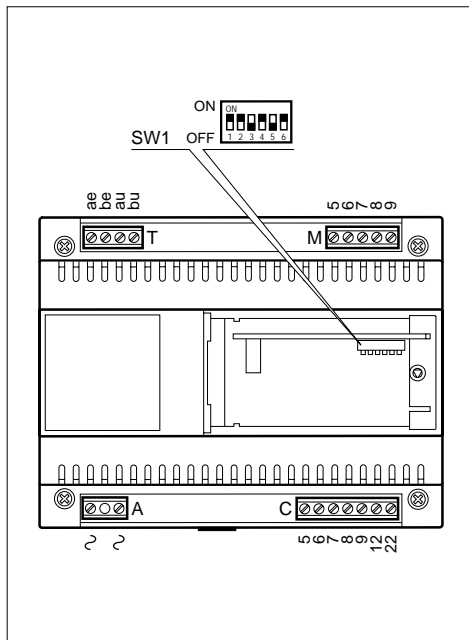
Je nach Anlagentyp (Abb. 3) sind die 6 DIL-Schalter (Abb. 2) einzustellen.

Über die Einstellung der Dip-Switch hinaus

muß - zur Wahl des Anlagentyps - der Apparat auch durch das Telefon programmiert werden (siehe PROGRAMMIERUNG). Die Einstellung des Apparat ermöglicht den Einbau in **Videosprechanlagen der Serie 200**.

*ACHTUNG. Für Haussprechanlagen ohne Mithörsperre hat die Programmierung des Geräts nach dem auf Seite 49 angezeigten Verfahren zu erfolgen.*

## DIP-SWITCH - EINSTELLUNG

DIP-SWITCH	HAUSSPRECHANLAGE	VIDEOSPRECHANLAGE SYSTEM 100	VIDEOSPRECHANLAGE SYSTEM 200
SW1	ON	ON	ON
SW2	OFF	OFF	ON
SW3	ON	OFF	ON
SW4	ON	OFF	ON
SW5	OFF	ON	OFF
SW6	ON	OFF	ON

Die Überbrückungsklemme SW1 wird nur während des PROGRAMMIER-Vorgangs auf OFF gestellt.

Abb. 3



# PROGRAMMIERUNG

## Standardkonfiguration

- Flasherkennungsmodus: freigegeben.
- Mithörsperre: eingeschaltet.
- Dauer des an der Haussprechanlage geführten Gesprächs: 60 Sekunden.
- Dauer des Modus Türöffnen: 1 Sekunde.
- Modalität: Anlagen mit Analoganruf.
- Programmierter Code für einen Anschluß an Anlagen mit codiertem Anruf: 80155.
- Flash-Auffangdienst: ausgeschaltet.
- Monitor: Kombination mit Telefon: XV/200.

## Beginn und Ende der Programmiervorgänge

Zur Programmierung durch das Telefon, das an die Telefonschnittstelle angeschlossen ist:



Sich vergewissern, daß der Telefonhörer aufgelegt ist.



Dip-Switch 1 auf OFF stellen.

*Während dieses Vorgangs können eine oder mehrere aufeinanderfolgende Programmierungen durchgeführt werden.*

*Die Eingabe der Programmiercodes ist während der Pause des Programmiertons auszuführen.*

## Um die Programmierung zu beenden:



Dip-Switch 1 auf ON stellen.



Bei Vorgangsende muß, durch das Abheben des Hörers oder Betätigung der Taste Freisprechfunktion, das Freizeichen der Telefonlinie hörbar sein.

## Betriebsart Mithörsperre



Hörer abnehmen

oder



Taste Freisprechfunktion drücken.

Nach diesem Vorgang muß ein doppelter Ton hörbar sein, der zum Programmierungsbeginn auffordert.



29 eingeben.



Für die Betriebsart Anlage ohne Mithörsperre 0 eingeben oder



1 für die Betriebsart Anlage mit Mithörsperre.

Am Ende muß ein dreifacher Bestätigungston hörbar sein.



Hörer wieder auflegen

oder



Taste Freisprechfunktion drücken.

# PROGRAMMIERUNG

## Dauer des an der Haussprechanlage geführten Gesprächs



Hörer abnehmen  
oder



Taste Freisprechfunktion drücken.

Nach diesem Vorgang muß ein doppelter Ton hörbar sein, der zum Programmierungsbeginn auffordert.



27 eingeben.



Gesprächsdauer (von 10 bis 99 Sekunden) eingeben, z.B. 20 für 20 Sekunden.

Am Ende muß ein dreifacher Bestätigungston hörbar sein.



Mikrotelefon wieder einhängen  
oder



Taste Freisprechfunktion drücken.

**ANMERKUNG.** Die Veränderung der Zeiteingabe ist nur in den Haussprechanlagen ohne Mithörsperre (z.B. mit A/200R) möglich.

## Analoge oder codierte Modalität

(siehe den digitalen Außenstationen beiliegende Anleitungen)



Mikrotelefon abnehmen  
oder



Taste Freisprechfunktion drücken.

Nach diesem Vorgang muß ein doppelter Ton hörbar sein, der zum Programmierungsbeginn auffordert.



62 eingeben.



Für die Modalität analoge Anlage 0 eingeben (\*)  
oder



1 für die Modalität codierte Anlage eingeben.

Am Ende muß ein dreifacher Bestätigungston hörbar sein.



Hörer wieder auflegen  
oder



Taste Freisprechfunktion drücken.

(\*) Diese Programmierung ist nur dann nötig, wenn die zuvor durch digitale Codes programmierte Schnittstelle wieder konfiguriert werden soll.

# PROGRAMMIERUNG

## Code IT/200 in Block-/Bedienerformat und codierte Moduseingabe

(siehe den digitalen Außenstationen beiliegende Anleitungen)



Hörer abnehmen  
oder



Taste Freisprechfunktion drücken.

Nach diesem Vorgang muß ein doppelter Ton hörbar sein, der zum Programmierungsbeginn auffordert.



60 eingeben.



Blockcode (von 00 bis 80) eingeben, z.B. 39.



Bedienercode (von 000 bis 161) eingeben, z.B. 052.

Am Ende muß ein dreifacher Bestätigungston hörbar sein.



Hörer wieder auflegen  
oder



Taste Freisprechfunktion drücken.

## Code IT/200 in progressivem Format und codierte Moduseingabe

(siehe den digitalen Außenstationen beiliegende Anleitungen)



Hörer abnehmen  
oder



Taste Freisprechfunktion drücken.

Nach diesem Vorgang muß ein doppelter Ton hörbar sein, der zum Programmierungsbeginn auffordert.



61 eingeben.



Bedienercode (von 00000 bis 13121), z.B. 01523.

Am Ende muß ein dreifacher Bestätigungston hörbar sein.



Hörer wieder auflegen  
oder



Taste Freisprechfunktion drücken.

# PROGRAMMIERUNG

## Dauer der Türöffnersteuerung



Hörer abnehmen  
oder



Taste Freisprechfunktion  
drücken.

Nach diesem Vorgang muß ein doppelter Ton hörbar sein, der zum Programmierungsbeginn auffordert.

2 8

28 eingeben.



Die Dauer der Türöffnersteuerung (von 01 bis 15 Sekunden) eingeben, z.B. 06 für 6 Sekunden.

Am Ende muß ein dreifacher Bestätigungston hörbar sein.



Hörer wieder auflegen  
oder



Taste Freisprechfunktion  
drücken.

**ANMERKUNG.** Diese Funktion kann nur mit zentralisierten Netzgeräten ohne Zeitschalter (z.B. A/200R oder VA/100.01 auf manuelle Steuerung des Elektrotürschlosses eingestellt) betrieben werden.

## Flasherkennungsmodus



Hörer abnehmen  
oder



Taste Freisprechfunktion  
drücken.

Nach diesem Vorgang muß ein doppelter Ton hörbar sein, der zum Programmierungsbeginn auffordert.

2 0

20 eingeben.

0

Für die freigegebene Flasherkennung 0 eingeben

oder

1

1 für die lange Flasherkennung.

Am Ende muß ein dreifacher Bestätigungston hörbar sein.



Hörer wieder auflegen  
oder



Taste Freisprechfunktion  
drücken.

# PROGRAMMIERUNG

## Flash-Auffangfunktion



Hörer abnehmen  
oder



Taste Freisprechfunktion  
drücken.

Nach diesem Vorgang muß ein doppelter Ton hörbar sein, der zum Programmierungsbeginn auffordert.

6 3

63 eingeben.

0

Für die ausgeschaltete Flashauffangfunktion (Anschluß an Telefon XT/200) 0 eingeben

oder

1

1 für die eingeschaltete Flashauffangfunktion (Anschluß an allgemeines MFV-Telefon).

Am Ende muß ein dreifacher Bestätigungston hörbar sein.



Hörer wieder auflegen  
oder



Taste Freisprechfunktion  
drücken.

## Telefon mit Monitorkombination



Hörer abnehmen  
oder



Taste Freisprechfunktion  
drücken.

Nach diesem Vorgang muß ein doppelter Ton hörbar sein, der zum Programmierungsbeginn auffordert.

6 4

64 eingeben.

0

0 eingeben, wenn der Monitor XV/200 oder XVC/200 benutzt wird

oder  
1 wenn der Monitor IMT/200 oder IMTC/200 benutzt wird.

**ANMERKUNG.** Bei Anlagen mit Verschiedenen Sprechstellen wählen Sie 1.

Am Ende muß ein dreifacher Bestätigungston hörbar sein.



Hörer wieder auflegen  
oder



Taste Freisprechfunktion  
drücken.

---

# PROGRAMMIERUNG

## Wiederherstellung der Standardkonfiguration



Hörer abnehmen

oder



Taste Freisprechfunktion drücken.

Nach diesem Vorgang muß ein doppelter Ton hörbar sein, der zum Programmierungsbeginn auffordert.



00 eingeben.

Am Ende muß ein dreifacher Bestätigungston hörbar sein.



Hörer wieder auflegen

oder



Taste Freisprechfunktion drücken.

---

# TECHNISCHE DATEN

- Stromversorgung: 230 V AC, 50 Hz.
- Stromaufnahme: 6 VA max.
- Ausgangsspannung: 24 V.
- Rufspannung 50 V eff./50 Hz.
- Max. Länge der Anschlußkabel pro Sprechgarnitur: 100 m (Telefonkabel mit einem Querschnitt von 0,6 mm).
- Anzahl der Sprechgarnituren auf derselben Leitung: 5 max.
- Wiederherstellbare elektronische Schutzvorrichtung.
- Frequenzhub gemäß CCITT-Normen.
- Monitoreinschaltung für die gesamte Gesprächsdauer.
- Max. Gesprächsdauer an der Haussprechanlage: 99 s.
- Einzelanschluß für Treppenlichter (Typ OPEN COLLECTOR 24 V DC, 50 mA).
- Anschluß für Pförtneranruf.
- Regelbare Flashdauer (R).
- Dauer der Auslösung des Türöffners von 1 bis 15 s.
- Anschluß an die Amtsleitung auch bei fehlender Stromversorgung.
- Betriebstemperatur: von 0 °C bis +35 °C.
- Relative Luftfeuchtigkeit: 90% ohne Kondenswasser.
- Schutzklasse II.
- Abmessungen: 8 DIN-Einheiten, flach.
- Frequenz der Signaltöne: 375 Hz.

Das Gerät wurde gemäß den Vorschriften CTR 21 zugelassen und erfüllt die Vorschrift EN 60950 über die elektrische Sicherheit und die europäische Richtlinie 89/336/EEC, durch 93/68/EEC abgeändert, über die elektromagnetische Kompatibilität.

Die europäische Genehmigung wurde von BZT-ETS CERTIFICATION GmbH erlassen

**CE 0681 X**

# TÖNE UND RHYTHMEN

## Signaltöne

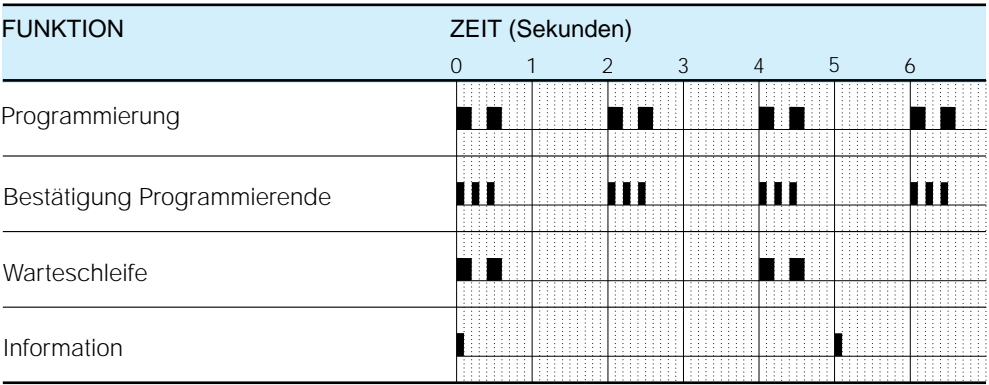

█ = Note    \_ = Pause

DEUTSCH

## Anrufrhythmen

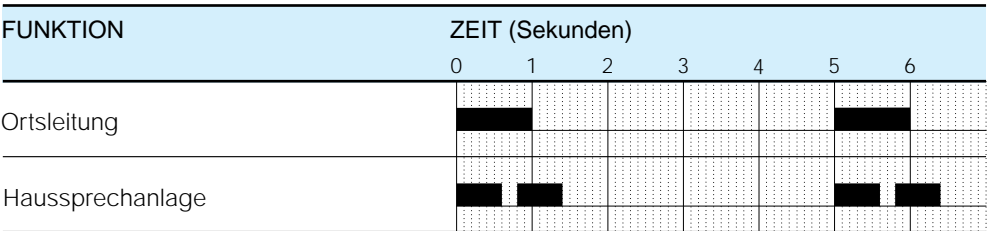

█ = Note    \_ = Pause



---

# GLOSSAR

## Sprechgarnitur

Ermöglicht die Verbindungsaufnahme zu der Außenstation und die Steuerung des Türöffners.

## Standard

Dieser Begriff definiert jegliche, vom Hersteller durchgeführte Voreinstellung oder Programmierung.

## Flash (R)

Durch diesen Tastendruck auf dem Telefon wird die Schnittstelle auf den Empfang einer Steuerfunktion vorbereitet.

## Amtsleitung

Verbindung, die ein Gespräch zwischen zwei Teilnehmer am öffentlicher Netz herstellt.

## Außenstation

Gibt dem Besucher die Möglichkeit, den Teilnehmer anzurufen und mit diesem ein Gespräch zu führen.

Falls mit Videokamera ausgestattet, werden die Bilder der Videosprechanlage ins Haus gesendet.

## Telefon

Ein Apparat, durch den man normalerweise Telefonanrufe auf der Amtsleitung empfängt und vornimmt; mit der Zentrale IT/200 kann es auch als Sprechgarnitur verwendet werden.

## IWV-Telefon

Telefon mit Wählscheibe oder auch mit Nummerntastatur. Die IWV-Wahl erkennt man daran, daß beim Anwählen einer Rufnummer in Hörer die Impulse herauszuhören sind.

## MFV-Telefon

Es handelt sich um ein Mehrfrequenztelefon, wenn beim Anwählen einer Rufnummer im Hörer einzelne Töne unterschiedlicher Frequenz zu hören sind.

## Videosprechgarnitur

Über die normalen Funktionen der Sprechgarnitur hinaus zeigt es auf dem Bildschirm den Besucher, der von der Außenstation anruft.

# FUNKTIONEN

## Anruf auf Amtsleitung

Die Anrufe können wie gewohnt, wie mit jeglichem anderen Apparat, vorgenommen werden.



Hörer abnehmen

oder



Taste Freisprechfunktion drücken.



Die gewünschte Rufnummer in die Tastatur eingeben.



Bei Gesprächsende Hörer wieder auflegen

oder



Taste Freisprechfunktion drücken.

## Beantwortung der eingehenden Anrufe



Hörer abnehmen

oder



Taste Freisprechfunktion drücken.



Bei Gesprächsende Hörer wieder auflegen

oder



Taste Freisprechfunktion drücken.

Das Telefon läutet mit unterschiedlichen Rhythmen, je nachdem, ob der Anruf von einer Ortsleitung oder von der Außenstation kommt.

Siehe Kapitel Klingel- TÖNE UND RHYTHMEN.

## Beantwortung des Anrufs von der Außenstation und Türöffner



Hörer abnehmen

oder



Taste Freisprechfunktion drücken.



Falls die anrufende Person eintreten soll, Taste Türöffner (für **bpt**-Telefone, für andere Telefone siehe zusammenfassende Tabelle) drücken.



Hörer wieder auflegen

oder



Taste Freisprechfunktion drücken.

*ANMERKUNG. Wenn die Schnittstelle auf ausgeschaltete FLASHAUFFANGFUNKTION programmiert ist, kann von einem Mehrfrequenz-Standardtelefon und bei bestehender Verbindung mit der Ortsleitung, keine Steuerfunktion ausgesendet werden.*

# FUNKTIONEN

## Selbsteinschaltung auf der Außenstation

Die Einschaltung der Außenstation ist infolge einer der folgenden Erfordernisse möglich:

- die Audio- und Videoüberwachung der Umgebung (falls die Außenstation über eine Videokamera verfügt);
- die Umschaltung zwischen den Außenstationen;
- die Betätigung des Türöffners.

**ANMERKUNG.** Die Selbsteinschaltung ist nur durch die Kombination mit dem Videomodul XV/200 und bei freier Videosprechanlage möglich.

## Wechsel des Gesprächsteilnehmers

Durch diese Dienstsfunktion kann der Bediener, der mit einer externen Leitung oder der Außenstation verbunden ist, auf einen Anruf auf einer anderen Leitung antworten, indem die bestehende Verbindung geparkt wird.

Ein akustischer Ton meldet dem geparkten Gesprächsteilnehmer diesen Zustand.

**ANMERKUNG.** Während des Gesprächs meldet ein akustischer Hinweis dem Bediener den eingehenden zweiten Anruf.

## Um während des Gesprächs auf einen anderen Teilnehmer umzuschalten:



Umschalttaste Sprechgarnitur / Telefon drücken (für **bpt**-Telefone, für andere Telefone siehe zusammenfassende Tabelle).

**ANMERKUNG.** Wenn die Schnittstelle auf ausgeschaltete FLASHAUFFANGFUNKTION programmiert ist, kann von einem Mehrfrequenz-Standardtelefon und bei bestehender Verbindung mit der Ortsleitung, keine Steuerfunktion ausgesendet werden.

## Pförtneranruf



Hörer abnehmen  
oder



Taste Freisprechfunktion drücken.

Ton abwarten, der zum Anwählen auffordert.



Taste Pförtneranruf drücken (für **bpt**-Telefone, für andere Telefone siehe zusammenfassende Tabelle).



Bei Gesprächsende Hörer wieder auflegen  
oder



Taste Freisprechfunktion drücken.

**ANMERKUNG.** Wenn die Schnittstelle auf ausgeschaltete FLASHAUFFANGFUNKTION programmiert ist, kann von einem Mehrfrequenz-Standardtelefon und bei bestehender Verbindung mit der Ortsleitung, keine Steuerfunktion ausgesendet werden.

# FUNKTIONEN

## Steuerung der Zusatzfunktion/Treppenlicht vom Telefon aus



Hörer abnehmen

oder



Taste Freisprechfunktion drücken.

Ton abwarten, der zum Anwählen auffordert.



Zusatztaste drücken (für **bpt**-Telefone, für andere Telefone siehe zusammenfassende Tabelle).



Hörer wieder auflegen

oder



Taste Freisprechfunktion drücken.

**ANMERKUNG.** Wenn die Schnittstelle auf ausgeschaltete FLASHAUFFANGFUNKTION programmiert ist, kann von einem DTMF-Telefon und bei bestehender Verbindung mit der Ortsleitung, keine Steuerfunktion ausgesendet werden.

**BEMERKUNG.** In Anlagen mit Mithörsperre ist diese Funktion nur dann verfügbar, wenn die Sprechgarnitur von der Außenstation angewählt wurde.

## Ausschaltung der Tonmeldung des ankommenden Anrufs



**R83** eingeben und dann die Telefonnummer wählen.

Während des ganzen Telefonanrufs bleibt das Meldezeichen ausgeschaltet.









Diese Funktion nur bei einem Modem-Anschluß benutzen. Falls die Ausschaltung automatisch erfolgen soll, ist die Zeichenfolge **!83**, (siehe Anweisungen Telefonanschluß-Software) hinzuzufügen.

## Zugang zu den Servicefunktionen DTMF der Telefongesellschaft

Der Zugang ist immer dann möglich, wenn die Schnittstelle als ausgeschaltete FLASH-SCHNITTSTELLE konfiguriert wurde; bei eingeschalteter FLASH-SCHNITTSTELLE nur dann, wenn eine Verbindung mit der Amtsleitung besteht und von der Außenstation der Haussprechanlage keine Anrufe erfolgen.

# FUNKTIONEN

Durch das **bpt** Telefon und die Standardtelefone zugängliche Funktionen

	BPT-TELEFON XT/200	MULTIFREQUENZ- TELEFON	IWV- TELEFON
PROGRAMMIERUNG	ja	ja	nicht möglich
ORTSGESPRÄCH	direkt	direkt	direkt
EMPFANG VON ORTSGESPRÄ- CHEN/TELEFONANRUFEN	ja	ja	ja
ZUGANG ZU DEN DTMF-TELE- KOM SERVICEFUNKTIONEN	ja	ja	nicht möglich
SELBSTEINSCHALTUNG	 (XV/200)	 (XV/200)	 (XV/200)
TÜRÖFFNER		R+85	nicht möglich
ZUSATZFUNKTION/TREPPEN- LICHTER (im Netzgerät dafür verfügbarer Ausgang)		R+88	nicht möglich
EINZELZUSATZFUNKTION/ TREPPENLICHTER (in IT/200 dafür verfügbare Ausgang) (¹)		R+88	nicht möglich
PFÖRTNERANRUF		R+87	nicht möglich
WECHSEL DES GESPRÄCHSTEILNEHMES		R+80	nicht möglich

(¹) Der Ausgang EINZELZUSATZFUNKTION/TREPPENLICHTER kann auch in Anlagen mit ZENTRALISIERTEN TREPPENLICHTERN benutzt werden, indem die Dip-Switch Nr. 4 und 5 auf OFF gestellt werden.



---

# SOMMAIRE

## Instructions pour l'installateur

Généralités .....	64
Conseils .....	65
Installation .....	66
Connexions .....	67
Mise en service .....	68
Programmation .....	69
- Configuration de default .....	69
- Entrée et sortie des opérations de programmation .....	69
- Mode secret de conversation .....	69
- Durée conversation portier électronique .....	70
- Mode analogique ou codifié .....	70
- Code IT/200 en format bloc/utilisateur et programmation mode codifié .....	71
- Code IT/200 en format progressif et programmation mode codifié .....	71
- Durée commande ouvre-porte .....	72
- Mode reconnaissance flash .....	72
- Interception flash .....	73
- Type de moniteur à associer au téléphone .....	73
- Rétablissement de la configuration de default .....	74
Caractéristiques techniques .....	75
Tonalités et rythmes .....	76
- Tonalités de signalisation .....	76
- Rythmes d'appel .....	76

## Instructions pour l'utilisateur

Glossaire .....	77
Fonctions .....	78
- Appel sur ligne urbaine .....	78
- Réponse aux appels en arrivée .....	78
- Réponse à un appel depuis poste extérieur et ouverture de la porte .....	78
- Autointroduction sur poste extérieur .....	79
- Changement d'interlocuteur .....	79
- Appel concierge .....	79
- Commande auxiliaire/minuterie avec téléphone .....	80
- Exclusion signal acoustique avertissant d'un appel en arrivée .....	80
- Accès aux services en DTMF de la compagnie de téléphone .....	80
- Fonctions possibles avec l'utilisation du téléphone <b>bpt</b> et avec des téléphones standard .....	81

---

# GENERALITES

L'interface téléphonique permet de relier un appareil téléphonique à la ligne portier vidéo et portier électronique série 200 et série 100, qu'elle soit codifiée ou non.

Outre le téléphone **bpt**, elle permet également d'utiliser des appareils de téléphone normaux à décades ou DTMF, des téléphones sans fil, un répondeur téléphonique, un modem, une PABX, etc.

L'appareil sert également à envoyer des appels à une centrale de conciergerie de type analogique ou digitale et de commander les fonctions ouvre-porte, minuterie centralisée, etc.

L'appareil est réalisé dans un boîtier DIN à 8 modules. Il se compose d'un circuit imprimé de base et d'une carte contenant les dip-switch pour la programmation et pour la sélection du type d'installation.

## Fonction

- Accès direct à la ligne urbaine.
- Connexion au système portier vidéo série 200 avec fonction d'autointroduction (si couplé au module moniteur).
- Connexion au système portier vidéo série 100.
- Connexion au système portier électronique avec ou sans secret de conversation.
- Secret de conversation pour installations BPT.
- Interface codifiée intégrée.
- Communication téléphonique même en absence d'alimentation secteur.
- Appel diversifié depuis poste extérieur/ligne téléphonique.
- Commande ouvre-porte.
- Commande auxiliaire/minuterie.
- Appel concierge.
- Mise en attente communication (urbaine/portier électronique).
- Protection ligne téléphonique.
- Programmation de l'appareil au moyen du téléphone.
- Alimentation par le secteur.



---

## CONSEILS

**Lire attentivement les instructions contenues dans le présent livret car elles fournissent d'importantes indications concernant la sécurité d'emploi, d'installation et d'entretien.**

Après avoir sorti l'appareil de son emballage, contrôler s'il est en bon état.

Les éléments de l'emballage (sachets en plastique, polystyrène expansé, etc.) ne doivent pas être laissés à la portée des enfants car ils pourraient être dangereux.

L'élimination de l'emballage doit être fait conformément aux normes en vigueur.

L'exécution de l'installation doit répondre aux normes de sécurité en vigueur.

**Ne pas faire passer au même endroit les câbles du téléphone et les câbles électriques.**

Installer l'appareil dans un local non poussiéreux, loin de tous appareils pouvant créer des dérangements électriques de haute fréquence comme par ex.: soudeuses, moteurs électriques, fours à micro-ondes, climatiseurs, etc.

Il est opportun de prévoir en amont de l'alimentation un interrupteur de coupure et de protection adéquat.

Avant de connecter l'appareil, s'assurer

que les données de la plaque signalétique correspond à celle du réseau de distribution.

Cet appareil ne devra être destiné qu'à l'emploi pour lequel il a été expressément conçu. Toute autre utilisation sera considérée comme impropre et dangereuse.

Le constructeur ne sera pas tenu responsable de tous dommages dérivant d'une utilisation inappropriée, erronée et irraisonnée. Avant d'effectuer toute opération de nettoyage ou d'entretien, couper le courant du réseau d'alimentation en ouvrant l'interrupteur de l'installation.

En cas de panne et/ou de défaillance de fonctionnement, couper le courant et ne pas manipuler l'appareil.

Pour toute réparation, s'adresser uniquement à un centre de service après-vente agréé.

Le non-respect des indications ci-dessus peut compromettre la sécurité de l'appareil. L'installateur doit s'assurer que les informations pour l'utilisateur, quand elles sont prévues, soient présentes sur l'appareil.

Tous les appareils constituant l'installation devront être destinés exclusivement à l'emploi pour lequel ils ont été conçus.

# INSTALLATION

L'appareil réalisé dans un boîtier à 8 unités bas, peut être installé sans couvre-bornes dans des boîtiers munis de rail DIN (EN 50022). Pour les dimensions d'encombrement, voir la fig. 1A.

Ou bien il peut être installé au mur, avec couvre-bornes, en utilisant le rail DIN fourni en standard. Pour les dimensions d'encombrement, voir la fig. 1B.

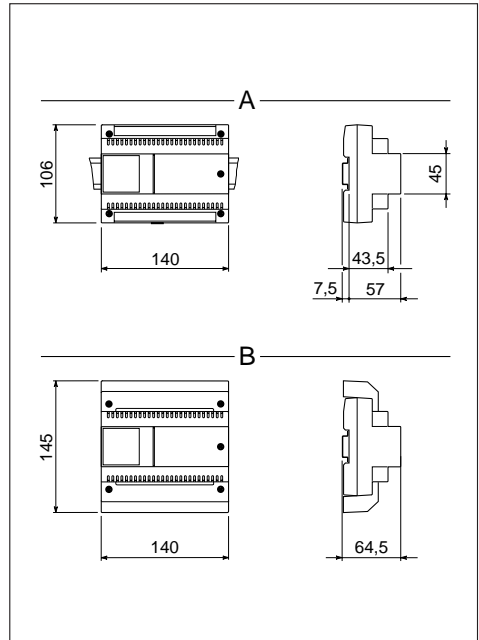

Fig. 1

# CONNEXIONS

Pour accéder aux borniers, enlever les couvre-bornes. Pour la connexion des téléphones, il est conseillé d'utiliser le câble de 6/10.

Distance maximale entre interface téléphonique et téléphone: 100 m.

**NOTA.** L'appareil ne doit être raccordé que sur des lignes téléphoniques analogiques et non pas sur des lignes digitales ISDN.

## Fonction des bornes

### Bornier T (ligne téléphonique)

- ae ligne urbaine
- be ligne urbaine
- au téléphone
- bu téléphone

### Bornier C (depuis alimentation)

- 5 masse
- 6 entrée alimentation moniteur
- 7 appel
- 8 audio depuis poste extérieur
- 9 audio au poste extérieur
- 12 appel conciergerie
- 22 auxiliaire/minuterie

### Bornier M (au poste intérieur)

- 5 masse
- 6 sortie alimentation moniteur
- 7 appel
- 8 audio depuis poste extérieur
- 9 audio au poste extérieur

### Bornier A

- ~ } secteur
- ~ }

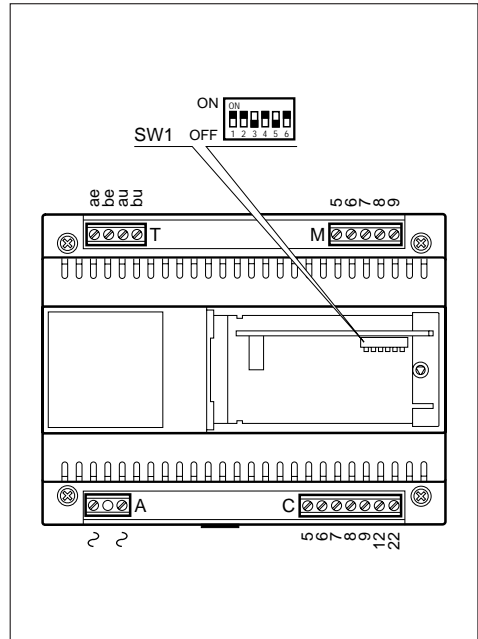

Fig. 2

# MISE EN SERVICE

L'appareil permet d'effectuer la connexion aux installations BPT suivantes:

- portier électronique conventionnel
- portier électronique avec seret de conversation
- portier vidéo système 100
- portier vidéo système 200
- appel électronique ou codifié

Il est doté de 6 dip-switch (fig. 2) à positionner en fonction du type d'installation (fig. 3).

Outre la programmation des dip-switch, il

faut également effectuer une programmation avec le téléphone pour le choix du type d'installation (voir chapitre PROGRAMMATION).

L'appareil est prévu pour être installé dans des installations **portier vidéo système 200**.

*ATTENTION. Pour des installations de portier électronique sans secret de conversation, il est nécessaire de programmer l'appareil selon les modalités indiquées à la page 69.*

## POSITION DES DIP-SWITCH

DIP-SWITCH	PORTIER ELECTRONIQUE	PORTIER VIDEO SYSTEME 100	PORTIER VIDEO SYSTEME 200
SW1	ON	ON	ON
SW2	OFF	OFF	ON
SW3	ON	OFF	ON
SW4	ON	OFF	ON
SW5	OFF	ON	OFF
SW6	ON	OFF	ON

Le cavalier SW1 sera positionné sur ON uniquement pendant les opérations de PROGRAMMATION.

Fig. 3

# PROGRAMMATION

## Configuration de default

- Mode reconnaissance flash: homologué.
- Secret de conversation: activé.
- Durée de conversation portier électronique: 60 s.
- Durée commande ouvre-porte: 1 s.
- Mode: installation avec appel analogique.
- Code programmé pour connexion dans des installations avec appel codifié: 80155.
- Interception flash: exclu.
- Type de moniteur associé au téléphone: XV/200.

## Entrée et sortie des opérations de programmation

Pour entrer en mode programmation avec le téléphone relié à l'interface téléphonique:



S'assurer que le récepteur du téléphone soit accroché.



Positionner le dip-switch 1 sur OFF.

*Pendant cette phase, il est possible d'effectuer une ou plusieurs programmations consécutives.*

*L'entrée des codes de programmation doit être effectuée pendant la pause de la tonalité de programmation.*

Pour sortir de la phase de programmation:



Positionner le dip-switch 1 sur ON.



En fin d'opération, lorsque l'on soulève le récepteur ou bien en appuyant sur la touche vive-voix, on doit entendre la tonalité de ligne téléphonique libre.

## Mode secret de conversation



Soulever le récepteur  
ou bien



appuyer sur la touche vive-voix.

Après cette opération, on doit entendre une double tonalité invitant à la programmation.



Taper 29.



Taper 0 pour mode installation sans secret  
ou bien



1 pour mode installation avec secret.

Après cette opération, on doit entendre une triple tonalité de confirmation.



Raccrocher  
ou bien



appuyer sur la touche vive-voix.

# PROGRAMMATION

## Durée conversation portier électronique



Soulever le récepteur  
ou bien



appuyer sur la touche vive-voix.

Après cette opération, on doit entendre une double tonalité invitant à la programmation.



Taper 27.



Taper la durée de la conversation (de 10 à 99 secondes). Ex: 20 pour 20 secondes.

Après cette opération, on doit entendre une triple tonalité de confirmation.



Raccrocher  
ou bien



appuyer sur la touche vive-voix.

**NOTE.** Le temps pourra être modifié uniquement pour des installations portier électronique sans secret de conversation (ex: avec A/200R).

## Mode analogique ou codifié

(voir instructions jointes aux postes extérieurs digitaux)



Soulever le récepteur  
ou bien



appuyer sur la touche vive-voix.

Après cette opération, on doit entendre une double tonalité invitant à la programmation.



Taper 62.



Taper 0 pour mode installation analogique (\*)  
ou bien



1 pour mode installation codifiée.

Après cette opération, on doit entendre une triple tonalité de confirmation.



Raccrocher  
ou bien



appuyer sur la touche vive-voix.

(\*) Cette programmation est nécessaire uniquement au cas où l'on souhaiterait reconfigurer l'interface précédemment programmée avec des codes digitaux.

# PROGRAMMATION

## Code IT/200 en format bloc/utilisateur et programmation mode codifié

(voir instructions jointes aux postes extérieurs digitaux)



Soulever le récepteur  
ou bien



appuyer sur la touche vive-voix.

Après cette opération, on doit entendre une double tonalité invitant à la programmation.



Taper 60.



Taper le code du bloc (de 00 à 80). Ex: 039.



Taper le code utilisateur (de 000 à 161). Ex: 052.

Après cette opération, on doit entendre une triple tonalité de confirmation.



Raccrocher  
ou bien



appuyer sur la touche vive-voix.

## Code IT/200 en format progressif et programmation mode codifié

(voir instructions jointes aux postes extérieurs digitaux)



Soulever le récepteur  
ou bien



appuyer sur la touche vive-voix.

Après cette opération, on doit entendre une double tonalité invitant à la programmation.



Taper 61.



Taper le code utilisateur (de 00000 à 13121). Ex: 01523.

Après cette opération, on doit entendre une triple tonalité de confirmation.



Raccrocher  
ou bien



appuyer sur la touche vive-voix.

# PROGRAMMATION

## Durée commande ouvre-porte



Soulever le récepteur  
ou bien



appuyer sur la touche vive-voix.

Après cette opération, on doit entendre une double tonalité invitant à la programmation.



Taper 28.



Taper la durée de la commande ouvre-porte (de 01 à 15 secondes). Ex: 06 pour 6 secondes.

Après cette opération, on doit entendre une triple tonalité de confirmation.



Raccrocher  
ou bien



appuyer sur la touche vive-voix.

**NOTE.** Il est possible d'utiliser cette fonction uniquement avec des alimentations sans programmeurs centralisés (ex: A/200R ou VA/100.01 programmé pour la commande serrure électrique manuelle).

## Mode reconnaissance flash



Soulever le récepteur  
ou bien



appuyer sur la touche vive-voix.

Après cette opération, on doit entendre une double tonalité invitant à la programmation.



Taper 20.



Taper 0 pour reconnaissance flash homologué  
ou bien



1 pour reconnaissance flash long.

Après cette opération, on doit entendre une triple tonalité de confirmation.



Raccrocher  
ou bien



appuyer sur la touche vive-voix.



# PROGRAMMATION

## Interception flash



Soulever le récepteur  
ou bien



appuyer sur la touche vive-voix.

Après cette opération, on doit entendre une double tonalité invitant à la programmation.



Taper 63.



Taper 0 pour interception flash exclu (connexion au téléphone XT/200)  
ou bien



1 pour interception flash activée (connexion au téléphone DTMF générique).

Après cette opération, on doit entendre une triple tonalité de confirmation.



Raccrocher  
ou bien



appuyer sur la touche vive-voix.

## Type de moniteur à associer au téléphone



Soulever le récepteur  
ou bien



appuyer sur la touche vive-voix.

Après cette opération, on doit entendre une double tonalité invitant à la programmation.



Taper 64.



Taper 0 lorsque vous utilisez le moniteur XV/200 ou XVC/200  
ou bien



1 lorsque vous utilisez le moniteur IMT/200 ou IMTC/200.

**NOTE.** Dans des installations avec postes intérieurs mixtes, taper 1.

Après cette opération, on doit entendre une triple tonalité de confirmation.



Raccrocher  
ou bien



appuyer sur la touche vive-voix.

---

# PROGRAMMATION

## Rétablissement de la configuration de default



Soulever le récepteur  
ou bien



appuyer sur la touche vive-voix.

Après cette opération, on doit entendre une double tonalité invitant à la programmation.



Taper 00.

Après cette opération, on doit entendre une triple tonalité de confirmation.



Raccrocher  
ou bien



appuyer sur la touche vive-voix.

---

# CARACTERISTIQUES TECHNIQUES

- Alimentation: 230 Vca 50 Hz.
- Consommation: 6 VA maxi.
- Tension de sortie: 24 V.
- Tension d'appel: 50V eff./50 Hz.
- Long. maxi des câbles de connexion pour chaque poste intérieur: 100 m (câble téléphonique de 6/10).
- Nombre de postes intérieurs sur la même ligne: 5 maxi.
- Possibilité de rétablir la protection électronique.
- Déviation de fréquence: suivant les normes CCITT.
- Mise en service moniteur pour la durée de la conversation.
- Durée maximum conversation portier électronique: 99 s.
- Connexion pour minuteur: simple (type OPEN COLLECTOR 24 Vcc, 50 mA).
- Connexion pour appel concierge.
- Durée temps flash (R) programmable.
- Durée temps d'enclenchement ouvre-porte de 1 à 15 s.
- Connexion ligne urbaine même en absence d'alimentation secteur.
- Température de fonctionnement: de 0 °C à +35 °C.
- Humidité relative: 90% sans condensation.
- Classe d'isolation II.
- Dimensions: module de 8 unités bas pour rail DIN.
- Fréquence tonalités de signalisation: 375 Hz.

L'appareil est homologué suivant les normes CTR 21 et satisfait à la norme EN 60950 relative à la sécurité électrique et à la directive 89/336/EEC modifiée par la directive 93/68/EEC relative à la compatibilité électromagnétique.

Approbation européenne délivrée par le BZT-ETS CERTIFICATION GmbH

## CE 0681 X

# TONALITES ET RYTHMES

## Tonalités de signalisation

FONCTION	TEMPS (secondes)						
	0	1	2	3	4	5	6
Programmation	■ ■		■ ■		■ ■		■ ■
Confirmation de fin de programmation	■ ■ ■		■ ■ ■		■ ■ ■		■ ■ ■
Attente	■ ■				■ ■		
Avis	■					■	

■ = Note    \_ = Pause

## Rythmes d'appel

FONCTION	TEMPS (secondes)						
	0	1	2	3	4	5	6
Urbaine	■ ■ ■ ■					■ ■ ■ ■	
Portier électronique	■ ■ ■	■ ■ ■				■ ■ ■	■ ■ ■

■ = Note    \_ = Pause

---

# GLOSSAIRE

## Combiné

Il permet de communiquer avec le poste extérieur et de commander l'ouverture de la porte.

## Default

On entend avec ce terme toute opération prévue sur l'appareil ou programmation effectuée en usine par le fabricant.

## Flash (R)

En appuyant sur cette touche sur le téléphone relié, l'interface est prête à recevoir une commande (et non un numéro de téléphone) effectuée avec le clavier.

## Ligne urbaine

Connexion qui permet de communiquer avec les abonnés de l'annuaire téléphonique.

## Poste extérieur

Il permet au visiteur d'appeler la personne intéressée et de converser. S'il est doté de caméra, il transmet les images sur le moniteur installée dans la maison.

## Téléphone

Appareil qui normalement permet de téléphoner ou de recevoir une communication téléphonique sur la ligne urbaine. Avec la centrale IT/200, le téléphone peut également être utilisé comme combiné.

## Téléphone à décades

Téléphone à cadran: certains téléphones à touches sont également à décades: un téléphone est à décades si, lorsque l'on compose un numéro, on entend dans le récepteur les unités.

## Téléphone multifréquence

Il est également appelé MF ou DTMF, c'est le téléphone le plus moderne. Un téléphone est multifréquence si lorsque l'on compose un numéro, on entend dans le récepteur des tonalités.

## Portier vidéo

Outre les fonctions du combiné, il permet de voir sur un écran le visiteur qui appelle depuis le poste extérieur.

# FONCTIONS

## Appel sur ligne urbaine

Il est possible d'appeler comme avec les autres appareils.



Soulever le récepteur  
ou bien



appuyer sur la touche vive-voix.



Composer sur le clavier le  
numéro désiré.



En fin de conversation, raccro-  
cher  
ou bien



appuyer sur la touche vive-voix.

## Réponse aux appels en arrivée



Soulever le récepteur  
ou bien



appuyer sur la touche vive-voix.



En fin de conversation, raccro-  
cher  
ou bien



appuyer sur la touche vive-voix.

*Le téléphone sonne avec des rythmes différents suivant que l'appel provienne d'une ligne urbaine ou bien du poste extérieur. Voir le chapitre TONALITES ET RYTHMES de la sonnerie.*

## Réponse à un appel provenant du poste extérieur et ouverture de la porte



Soulever le récepteur  
ou bien



appuyer sur la touche vive-voix.



Si vous désirez faire entrer le visiteur, appuyer sur la touche ouvre-porte (pour les téléphones **bpt**. Pour d'autres téléphones, consulter le tableau récapitulatif).



Raccrocher  
ou bien



appuyer sur la touche vive-voix.

*NOTE. Si l'interface est programmée avec la fonction INTERCEPTION FLASH exclue, avec un téléphone standard multifréquence, il n'est pas possible d'effectuer cette commande si l'on est en communication avec la ligne urbaine.*

# FONCTIONS

## Autointroduction sur le poste extérieur

Il est possible d'activer le poste extérieur pour l'un des besoins suivants:

- surveiller l'extérieur avec portier audio et vidéo (si le poste extérieur est doté de caméra);
- échanger les postes extérieurs;
- enclencher l'ouvre-porte.

**NOTE.** *L'autointroduction est possible uniquement si l'appareil est couplé au module vidéo XV/200 et avec installation portier vidéo libre.*

## Changement d'interlocuteur

Ce service permet à l'utilisateur en communication avec une ligne extérieure ou un poste extérieur de répondre à un appel provenant de l'autre ligne en mettant en attente la communication en cours.

L'interlocuteur qui ne converse pas est informé de cette condition moyennant une tonalité acoustique.

**NOTE.** *Pendant la conversation, l'utilisateur est informé de l'appel en arrivée avec un avis acoustique.*

**Pour changer d'interlocuteur pendant une conversation:**



Appuyer sur la touche de commutation combiné/téléphone (pour les téléphones **bpt**. Pour les autres types de téléphones, consulter le tableau récapitulatif).

**NOTE.** *Si l'interface est programmée avec la fonction INTERCEPTION FLASH exclue, avec un téléphone standard multifréquence, il n'est pas possible d'effectuer cette commande si l'on est en communication avec la ligne urbaine.*

## Appel concierge



Soulever le récepteur  
ou bien



appuyer sur la touche vive-voix.

Attendre la tonalité invitant à la sélection.



Appuyer sur la touche appel concierge (pour les téléphones **bpt**. Pour les autres téléphones, consulter le tableau récapitulatif).



En fin de conversation, raccrocher  
ou bien



appuyer sur la touche vive-voix.

**NOTE.** *Si l'interface est programmée avec la fonction INTERCEPTION FLASH exclue, avec un téléphone standard multifréquence, il n'est pas possible d'effectuer cette commande si l'on est en communication avec la ligne urbaine.*

# FONCTIONS

## Commande auxiliaire/minuterie avec téléphone



Soulever le récepteur

ou bien



appuyer sur la touche vive-voix.

Attendre la tonalité invitant à la sélection.



Appuyer sur la touche auxiliaire (pour les téléphones **bpt**. Pour les autres téléphones, consulter le tableau récapitulatif).



Raccrocher

ou bien



appuyer sur la touche vive-voix.

**NOTE.** Si l'interface est programmée avec la fonction **INTERCEPTION FLASH** exclue, avec un téléphone **DTMF**, il n'est pas possible d'effectuer cette commande si l'on est en communication avec la ligne urbaine.

**ATTENTION.** Dans des installations avec secret de conversation, cette commande est disponible uniquement si le poste intérieur a été appelé depuis le poste extérieur.

## Exclusion signal acoustique avertissant d'un appel en arrivée



Taper **R83** avant de composer le numéro de téléphone.

Pendant tout le temps de la conversation, le ton du signal acoustique est exclus.

Utiliser cette fonction pour effectuer un raccrochement à un modem. Si l'on désire obtenir l'exclusion en automatique, ajouter la série de caractères **!83**, (voir la notice du logiciel de la connexion téléphonique).









## Accès aux services en DTMF de la compagnie de téléphone

L'accès est toujours possible lorsque l'on a configuré l'interface avec **INTERCEPTION FLASH** exclue. Lorsqu'elle est configurée avec **INTERCEPTION FLASH** enclenchée, l'accès est possible uniquement en communication avec la ligne urbaine et en absence d'appels depuis le poste extérieur du portier électronique.



# FONCTIONS

## Fonctions possibles avec l'utilisation du téléphone **bpt** et avec des téléphones standard

	TELEPHONE BPT XT/200	TELEPHONE MULTIFREQUENCE	TELEPHONE A DECADES
PROGRAMMATION	oui	oui	impossible
APPEL URBAIN	direct	direct	direct
RECEPTION APPELS URBAINS/TELEPHONIQUES	oui	oui	oui
ACCES AUX SERVICES TELECOM EN DTMF	oui	oui	impossible
AUTOINTRODUCTION	 (XV/200)	 (XV/200)	 (XV/200)
OUVRE-PORTE		R+85	impossible
AUXILIAIRE/MINUTERIE CENTRALISEE (sortie disponible sur alimentation)		R+88	impossible
AUXILIAIRE/MINUTERIE SIMPLE (sortie disponible sur IT/200) (¹)		R+88	impossible
APPEL CONCIERGE		R+87	impossible
CHANGEMENT INTERLOCUTEUR		R+80	impossible

(¹) Il est également possible d'utiliser la sortie AUXILIAIRE/MINUTERIE SIMPLE dans des installations avec MINUTERIE CENTRALISEE en mettant les dip-switch 4 et 5 sur OFF.



# INDICE

## Instrucciones para el instalador

Características generales	.84
Advertencias	.85
Instalación	.86
Conexiones	.87
Puesta en marcha	.88
Programación	.89
- Configuración por defecto	.89
- Entrada y salida de las operaciones de programación	.89
- Modalidad secreto de conversación	.89
- Duración conversación de portero electrónico	.90
- Modalidad analógico o codificado	.90
- Código IT/200 en formato bloque/usuario y programación en modo codificado	.91
- Código IT/200 en formato progresivo y programación en modo codificado	.91
- Duración mando de control abrepuerta	.92
- Modalidad reconocimiento flash	.92
- Reconocimiento señal flash	.93
- Tipo de monitor a combinar con el teléfono	.93
- Reactivación de la configuración por defecto	.94
Características técnicas	.95
Tonos y señales de llamada	.96
- Tonos de indicación	.96
- Tonos de llamada	.96

## Instrucciones para el usuario

Glosario	.77
Funciones	.98
- Llamada en línea urbana	.98
- Respuesta a las llamadas entrantes	.98
- Respuesta a las llamadas desde placa exterior y apertura de la puerta	.98
- Autoactivación de la placa exterior	.99
- Cambio interlocutor	.99
- Llamada conserje	.99
- Mando de control auxiliar/ luz escalera desde el teléfono	.100
- Inhabilitación aviso acústico de llamada en entrada	.100
- Acceso a los servicios en DTMF de la compañía telefónica	.100
- Funciones que se pueden obtener al utilizar el teléfono <b>bpt</b> y con los teléfonos estándar	.101

---

# CARACTERISTICAS GENERALES

El interfaz telefónico permite la conexión de un aparato telefónico a la línea de videoportero o portero electrónico de la serie 200 y de la serie 100, esté o no codificado.

Permite la utilización del teléfono **bpt** y de aparatos de teléfonos normales decádicos o DTMF, inalámbricos, contestador automático, módem, PABX, etc.

El aparato también permite enviar llamadas a una centralita de conserjería de tipo analógico o digital y controlar los mandos abrepuerta, luz escalera centralizada, etc.

El aparato realizado en formato DIN de 8 módulos, está compuesto de un circuito impreso y por una tarjeta que contiene los dip-switch para realizar la programación y la selección del tipo de instalación.

## Funciones básicas

- Acceso directo a la línea urbana.
- Conexión al sistema de videoportero serie 200 con función de autoactivación (si se combina con el módulo monitor).
- Conexión al sistema de videoportero serie 100.
- Conexión al sistema de portero electrónico con o sin secreto de conversación.
- Secreto de conversación para equipos BPT.
- Codificador/decodificador de llamada integrado.
- Comunicación telefónica aunque la red no suministre alimentación.
- Tono de llamada diferente desde la placa exterior/línea telefónica.
- Mando de control abrepuerta.
- Mando de control auxiliar/luz escalera.
- Llamada conserje.
- Llamada en espera (urbana/de portero electrónico).
- Protección línea telefónica frente a sobrecargas.
- Programación del aparato desde el teléfono.
- Alimentación por red eléctrica.

---

# ADVERTENCIAS

Leer atentamente las advertencias incluidas en este manual ya que proporcionan indicaciones importantes con respecto a la seguridad de utilización, instalación y mantenimiento.

Después de haber desembalado el aparato, comprobar que está en perfectas condiciones.

Los elementos del embalaje (bolsas de plástico, espuma de poliestireno, etc.) no se deben dejar al alcance de los niños ya que representan potenciales fuentes de peligro.

La eliminación de los embalajes se debe realizar de acuerdo con las normas vigentes.

La ejecución de la instalación tiene que respetar las normas de seguridad en vigor.

**No instalar los cables telefónicos por el mismo recorrido que los cables eléctricos.**

Instalar la centralita en ambientes sin polvo, lejos de equipos que puedan generar perturbaciones eléctricas de alta frecuencia como: soldadores, motores eléctricos, hornos microondas, acondicionadores de aire, etc.

Se aconseja instalar a al entrada del alimentador un interruptor de características y protección adecuado.

Antes de conectar el aparato, habrá que comprobar que los datos de la placa corresponden a los de la red de distribución.

Este aparato se tiene que utilizar únicamente para el objetivo para el que ha sido diseñado; cualquier otro tipo de uso se considerará impropio y peligroso.

El fabricante no puede ser considerado responsable por posibles daños derivados de usos impropios, erróneos o irracionales. Antes de realizar cualquier operación de limpieza o de mantenimiento, abrir el interruptor de la instalación para desconectar el aparato de la red de alimentación eléctrica.

En caso de avería y/o mal funcionamiento del aparato, habrá que desconectarlo de la alimentación eléctrica y no manipularlo.

Si es necesario realizar alguna reparación, habrá que dirigirse únicamente a un centro de asistencia técnica autorizado por el fabricante.

Si no se respetan estas advertencias, se compromete gravemente la seguridad del aparato.

El instalador tendrá que asegurarse de que la información dirigida al usuario, donde esté prevista, se entregue junto a los aparatos.

Todos los aparatos que forman la instalación se tienen que utilizar únicamente para el objetivo para el que han sido diseñados.

# INSTALACION

El interfaz se presenta en un módulo bajo de 8 unidades y se puede instalar sin protege bornes en cajas dotadas de guía DIN (EN 50022).

Por lo que respecta a las dimensiones véase la fig. 1A.

También se puede instalar en la pared, con protege bornes, utilizando la guía DIN que se entrega junto al aparato.

Por lo que respecta a las dimensiones véase la fig. 1B.

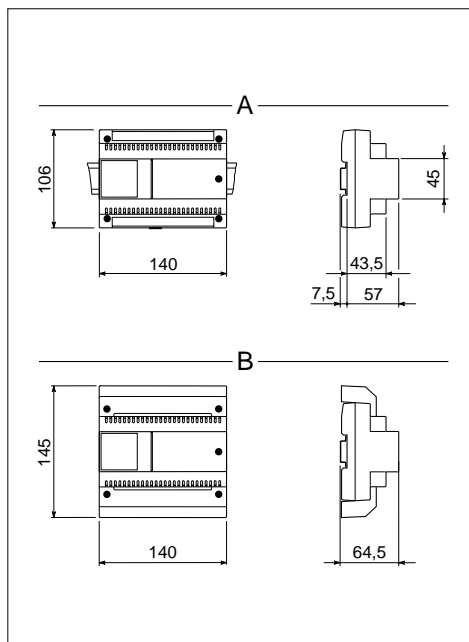

Fig. 1

# CONEXIONES

Para acceder a las borneras extraer las tapas protectoras. Se aconseja utilizar cable telefónico de 6/10 para realizar la conexión de los teléfonos.

Distancia máxima entre interfaz telefónico y teléfono: 100 m.

**NOTA.** El aparato debe conectarse sólo con líneas telefónicas analógicas, no con líneas digitales ISDN.

## Función de los bornes

### Bornera T (línea telefónica)

- ae línea urbana
- be línea urbana
- au teléfono
- bu teléfono

### Bornera C (del alimentador)

- 5 masa
- 6 entrada alimentación monitor
- 7 llamada
- 8 audio desde la placa exterior
- 9 audio hacia la placa exterior
- 12 llamada conserjería
- 22 auxiliar/luz escalera

### Bornera M (en el derivado interno)

- 5 masa
- 6 salida alimentación monitor
- 7 llamada
- 8 audio desde la placa exterior
- 9 audio hacia la placa exterior

### Bornera A

- ~ } red
- ~ }

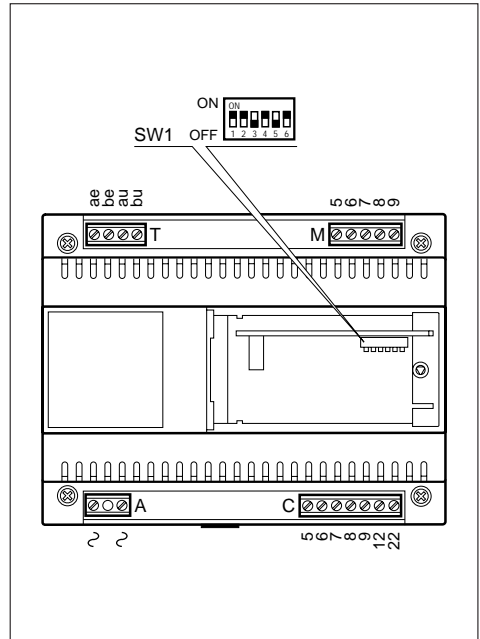

Fig. 2

# PUESTA EN MARCHA

El interfaz permite la conexión a los siguientes tipos de equipos BPT:

- portero electrónico convencional
- portero electrónico con secreto de conversación
- videoportero sistema 100
- videoportero sistema 200
- llamada electrónica o codificada

Dispone de 6 dip-switch (fig. 2) a configurar en función del tipo de equipo (fig. 3).

Además de la programación de los dip-switch, en el aparato también se tiene que

programar el tipo de instalación del equipo. Para realizar esta operación se utiliza el teléfono (véase el capítulo PROGRAMACION).

El aparato es compatible con las instalaciones en equipos de **videoportero sistema 200**.

*ATENCIÓN. Para las instalaciones de portero electrónico sin secreto de conversación es preciso programar el aparato según la modalidad indicada en la página 89.*

## PREPARACION DIP-SWITCH

DIP-SWITCH	PORTERO ELECTRONICO	VIDEOPORTERO SISTEMA 100	VIDEOPORTERO SISTEMA 200
SW1	ON	ON	ON
SW2	OFF	OFF	ON
SW3	ON	OFF	ON
SW4	ON	OFF	ON
SW5	OFF	ON	OFF
SW6	ON	OFF	ON

El puente **SW1** se coloca en posición OFF sólo durante el procedimiento de PROGRAMACION.

Fig. 3



# PROGRAMACION

## Configuración por defecto

- Modalidad reconocimiento flash: estándar homologado.
- Secreto de conversación: activo.
- Duración conversación portero electrónico: 60 s.
- Duración mando de control abrepuerta: 1 s.
- Modalidad: equipos con llamada analógica.
- Código programado para conexiones en equipos con llamada codificada: 80155.
- Reconocimiento señal flash: deshabilitada.
- Tipo de monitor combinado con el teléfono: XV/200.

## Entrada y salida de las operaciones de programación

Para entrar en modo programación desde el teléfono conectado al interfaz telefónico:



Asegurarse de que el auricular está colgado.



Colocar el dip-switch 1 en posición OFF.

*Durante esta fase se puede ejecutar una o varias operaciones de programación consecutivas.*

*El tecleo de los códigos de programación debe ser efectuado durante la pausa del tono de programación.*

## Para salir de la fase de programación:



Colocar el dip-switch 1 en posición ON.



Cuando se active el teléfono, una vez finalizado el procedimiento, se tiene que oír el tono de línea telefónica libre.

## Modalidad secreto de conversación



Descolgar el auricular

o



pulsar la tecla manos libres.

Después de esta operación se tendrá que oír un tono doble como invitación a realizar la programación.



Marcar 29.



Marcar 0 para la modalidad de equipo sin secreto

o



1 para la modalidad de equipo con secreto.

Al terminar se oirá un tono triple de confirmación.



Colgar el auricular

o



pulsar la tecla manos libres.

# PROGRAMACION

## Duración conversación de portero electrónico



Descolgar el auricular

o



pulsar la tecla manos libres.

Después de esta operación se tendrá que oír un tono doble como invitación a realizar la programación.



Marcar 27.



Teclear la duración de la conversación (de 10 a 99 segundos). Ej.: 20 para 20 segundos.

Al terminar se oirá un tono triple de confirmación.



Colgar el auricular

o



pulsar la tecla manos libres.

**NOTA.** El tiempo se puede variar únicamente en los equipos de portero electrónico sin secreto de conversación (ej. con A/200R).

## Modalidad analógico o codificado

(véanse instrucciones de las placas exteriores digitales)



Descolgar el auricular

o



pulsar la tecla manos libres.

Después de esta operación se tendrá que oír un tono doble como invitación a realizar la programación.



Marcar 62.



Marcar 0 para la modalidad de equipo analógico (\*)

o



1 para la modalidad de equipo codificado.

Al terminar se oirá un tono triple de confirmación.



Colgar el auricular

o



pulsar la tecla manos libres.

(\*) Este tipo de programación sólo es necesaria si se desea configurar de nuevo la interfaz anteriormente programada con códigos digitales.

# PROGRAMACION

## Código IT/200 en formato bloque/usuario y programación en modo codificado

(véanse instrucciones de las placas exteriores digitales)



Descolgar el auricular

o



pulsar la tecla manos libres.

Después de esta operación se tendrá que oír un tono doble como invitación a realizar la programación.

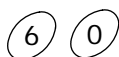

Marcar 60.



Teclear el código de bloque (de 00 a 80), ej. 39.



Teclear el código de usuario (de 000 a 161), ej. 052.

Al terminar se oirá un tono triple de confirmación.



Colgar el auricular

o



pulsar la tecla manos libres.

## Código IT/200 en formato progresivo y programación en modo codificado

(véanse instrucciones de las placas exteriores digitales)



Descolgar el auricular

o



pulsar la tecla manos libres.

Después de esta operación se tendrá que oír un tono doble como invitación a realizar la programación.



Marcar 61.



Teclear el código de usuario (de 00000 a 13121), ej. 01523.

Al terminar se oirá un tono triple de confirmación.



Colgar el auricular

o



pulsar la tecla manos libres.

# PROGRAMACION

## Duración mando de control abrepuerta



Descolgar el auricular

o



pulsar la tecla manos libres.

Después de esta operación se tendrá que oír un tono doble como invitación a realizar la programación.



Marcar **28**.



Teclear la duración del mando de control abrepuerta (de 01 a 15 segundos).  
Ej.: 06 para 6 segundos.

Al terminar se oír un tono triple de confirmación.



Colgar el auricular

o



pulsar la tecla manos libres.

**NOTA.** Se puede utilizar esta función con alimentadores que no tengan un temporizador centralizado (ej. A/200R o VA/100.01 programado con mando de cierre manual).

## Modalidad reconocimiento flash



Descolgar el auricular

o



pulsar la tecla manos libres.

Después de esta operación se tendrá que oír un tono doble como invitación a realizar la programación.



Marcar **20**.



Marcar **0** para el reconocimiento estándar homologado flash

o



**1** para el reconocimiento flash prolongado.

Al terminar se oír un tono triple de confirmación.



Colgar el auricular

o



pulsar la tecla manos libres.

# PROGRAMACION

## Reconocimiento señal flash



Descolgar el auricular

o



pulsar la tecla manos libres.

Después de esta operación se tendrá que oír un tono doble como invitación a realizar la programación.

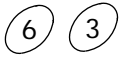

Marcar **63**.



Marcar **0** para deshabilitar el reconocimiento de la señal flash (conexión al teléfono XT/200)

o



**1** para habilitar el reconocimiento de la señal flash (conexión al teléfono DTMF genérico).

Al terminar se oirá un tono triple de confirmación.



Colgar el auricular

o



pulsar la tecla manos libres.

## Tipo de monitor a combinar con el teléfono



Descolgar el auricular

o



pulsar la tecla manos libres.

Después de esta operación se tendrá que oír un tono doble como invitación a realizar la programación.



Marcar **64**.



Marcar **0** cuando se utiliza el monitor XV/200 o XVC/200

o



**1** cuando se utiliza el monitor IMT/200 o IMTC/200.

**NOTA.** En instalaciones con derivados internos mixtos marcar **1**.

Al terminar se oirá un tono triple de confirmación.



Colgar el auricular

o



pulsar la tecla manos libres.

---

# PROGRAMACION

## Reactivación de la configuración por defecto



Descolgar el auricular

o



pulsar la tecla manos libres.

Después de esta operación se tendrá que oír un tono doble como invitación a realizar la programación.



Marcar 00.

Al terminar se oirá un tono triple de confirmación.



Colgar el auricular

o



pulsar la tecla manos libres.

---

# CARACTERISTICAS TECNICAS

- Alimentación: 230 Vca - 50 Hz.
- Consumo: 6 VA máx.
- Tensión de salida: 24 V.
- Tensión de llamada: 50 V ef./50 Hz.
- Longitud máx. de los cables de conexión de cada interno: 100 m (cable telefónico de 6/10).
- Cantidad derivados en la misma línea: 5 máx.
- Protección electrónica reactivable.
- Desviación de frecuencia: según las normas CCITT.
- Habilitación monitor durante la conversación.
- Duración máxima conversación de portero electrónico: 99 s.
- Conexión para luz escaleras individual (tipo OPEN COLLECTOR 24 Vcc, 50 mA).
- Conexión para llamada conserje.
- Duración tiempo flash (R) programable.
- Duración tiempo de activación abrepuerta de 1 a 15 s.
- Conexión a la línea urbana incluso cuando falta alimentación.
- Temperatura de funcionamiento: de 0 °C a +35 °C.
- Humedad relativa: 90% sin condensación.
- Clase de aislamiento II.
- Dimensiones: módulo de 8 unidades bajo para guía DIN.
- Frecuencia tonos de indicación: 375 Hz.

El aparato está homologado según las normas CTR 21 y cumple con la norma EN 60950, relativa a la seguridad eléctrica y con la directiva 89/336/EEC modificada por la 93/68/EEC, relativas a la compatibilidad electromagnética.

Aprobación europea expedida por  
BZT-ETS CERTIFICATION GmbH

## CE 0681 X

# TONOS Y SEÑALES DE LLAMADA

## Tonos de indicación

FUNCION	TIEMPO (segundos)						
	0	1	2	3	4	5	6
Programación	■ ■		■ ■		■ ■		■ ■
Confirmación de final de programación	■ ■ ■		■ ■ ■		■ ■ ■		■ ■ ■
Espera	■ ■				■ ■		
Aviso	■					■	

■ = Nota    \_ = Pausa

## Tonos de llamada

FUNCION	TIEMPO (segundos)						
	0	1	2	3	4	5	6
Urbana	■ ■ ■ ■ ■ ■ ■ ■					■ ■ ■ ■ ■ ■ ■ ■	
Portero electrónico	■ ■ ■ ■ ■ ■ ■ ■	■ ■ ■ ■ ■ ■ ■ ■				■ ■ ■ ■ ■ ■ ■ ■	■ ■ ■ ■ ■ ■ ■ ■

■ = Nota    \_ = Pausa



---

# GLOSARIO

## Teléfono

Permite la comunicación con la placa exterior y además puede controlar la apertura de la puerta.

## Por defecto

Con estas palabras se define la programación establecida por el fabricante.

## Flash (R)

Si se pulsa esta tecla en el teléfono multifunción conectado, se prepara el interfaz para recibir un mando de control (no un número telefónico) del teclado.

## Línea urbana

Conexión que permite la comunicación con los usuarios de la red telefónica conmutada.

## Placa exterior

Permite que el visitante pueda efectuar una llamada al usuario y pueda conversar. Si dispone de cámara transmitirá la imagen al videoportero de casa.

## Teléfono multifunción

Aparato que normalmente permite realizar y recibir llamadas de la línea telefónica; con la centralita IT/200 el teléfono multifunción también se puede utilizar como portero electrónico.

## Teléfono multifunción decádico

Teléfono multifunción de disco con dial de diez números; algunos teléfonos con teclado también son decádicos: el teléfono es decádico si, cuando se marca un número, se oyen los impulsos de los pasos.

## Teléfono multifunción multifrecuencia

También se llama MF o DTMF, es el teléfono multifunción más moderno.

Un teléfono multifunción es multifrecuencia si, cuando se marca un número, en el auricular se oyen los tonos.

## Videoportero

Además de las funciones del portero electrónico normal, dispone de una pantalla donde aparece el visitante que se encuentra en la placa exterior.

# FUNCIONES

## Llamada en línea urbana

Se puede realizar una llamada de la manera habitual, como con cualquier otro aparato telefónico.



Descolgar el auricular

o



pulsar la tecla manos libres.



Marcar en el teclado el número deseado.



Una vez haya finalizado la conversación, colgar el auricular

o



pulsar la tecla manos libres.

## Respuesta a las llamadas entrantes



Descolgar el auricular

o



pulsar la tecla manos libres.



Una vez haya finalizado la conversación, colgar el auricular

o



pulsar la tecla manos libres.

El teléfono multifunción suena con un tono diferente dependiendo si la llamada procede de una línea urbana o de la placa exterior.

Véase el capítulo TONOS Y SEÑALES DE LLAMADA.

## Respuesta a las llamadas desde la placa exterior y apertura de la puerta



Descolgar el auricular

o



pulsar la tecla manos libres.



Si se desea hacer entrar a quien ha llamado, pulsar la tecla abrepuerta (en teléfonos multifunción **bpt**, si se utilizan otros teléfonos multifunción habrá que consultar la tabla correspondiente).



Colgar el auricular

o



pulsar la tecla manos libres.

*NOTA. Si el interfaz se ha programado con la función RECONOCIMIENTO SEÑAL FLASH deshabilitada, no se podrá ejecutar el mando de control cuando se esté en comunicación con la línea urbana si se trata de un teléfono multifunción estándar multifrecuencia.*

# FUNCIONES

## Autoactivación de la placa exterior

Se puede activar la placa exterior para satisfacer cualquiera de las siguientes exigencias:

- vigilar el exterior con audio y vídeo (si la placa exterior dispone de cámara);
- intercambiar las placas exteriores;
- activar el abrepuerta.

**NOTA.** *La autoactivación es posible sólo si se combina con el módulo vídeo XV/200 y si el equipo de videoportero está libre.*

## Cambio interlocutor

Este servicio permite que el usuario, en comunicación con una línea exterior o con la placa exterior, puede responder a una llamada procedente de la otra línea y poner a la espera la comunicación en curso.

El interlocutor que permanece a la espera lo sabe gracias a que oye un tono acústico.

**NOTA.** *Durante la conversación, se informa al usuario que tiene otra llamada entrante mediante un aviso acústico.*

### Para cambiar de interlocutor durante una conversación:



Pulsar la tecla de conmutación portero electrónico/teléfono (en teléfonos **bpt**, si se utilizan otros teléfonos habrá que consultar la tabla correspondiente).

**NOTA.** *Si el interfaz se ha programado con la función RECONOCIMIENTO SEÑAL FLASH deshabilitada, no se podrá ejecutar el mando de control cuando se esté en comunicación con la línea urbana si se trata de un teléfono multifunción estándar multifrecuencia.*

## Llamada conserje



Descolgar el auricular

o



pulsar la tecla manos libres.

Esperar el tono de invitación a la selección.



Pulsar la tecla de llamada conserje (en teléfonos **bpt**, si se utilizan otros teléfonos habrá que consultar la tabla correspondiente).



Una vez haya finalizado la conversación, colgar el auricular

o



pulsar la tecla manos libres.

**NOTA.** *Si el interfaz se ha programado con la función RECONOCIMIENTO SEÑAL FLASH deshabilitada, no se podrá ejecutar el mando de control cuando se esté en comunicación con la línea urbana si se trata de un teléfono multifunción estándar multifrecuencia.*

# FUNCIONES

## Mando de control auxiliar/luz escalera desde el teléfono multifunción



Descolgar el auricular

o



pulsar la tecla manos libres.

Esperar el tono de invitación a la selección.



Pulsar la tecla auxiliar (en teléfonos **bpt**, si se utilizan otros teléfonos habrá que consultar la tabla correspondiente).



Colgar el auricular

o



pulsar la tecla manos libres.

**NOTA.** Si el interfaz se ha programado con la función RECONOCIMIENTO SEÑAL FLASH deshabilitada, no se podrá ejecutar el mando de control cuando se esté en comunicación con la línea urbana si se trata de un teléfono multifunción estándar multi-frecuencia.

**ADVERTENCIA.** En equipos con secreto de conversación, este mando de control se puede utilizar sólo si se ha llamado al derivado interno desde la placa exterior.

## Inhabilitación aviso acústico de llamada en entrada



Marcar **R83** antes de marcar el número de teléfono.

Durante todo el tiempo de la conversación el tono de aviso queda inhabilitado.

Utilizar esta función cuando se realiza la conexión con un módem.









Si se desea obtener automáticamente la inhabilitación es preciso añadir la serie de caracteres **!83**, (ver las instrucciones del software de la conexión telefónica).

## Acceso a los servicios en DTMF de la compañía telefónica

El acceso es posible si el interfaz se ha programado con la función RECONOCIMIENTO SEÑAL FLASH deshabilitada. También es posible si se está en comunicación con la línea urbana y sin llamadas desde la placa exterior, siempre y cuando, el interfaz se haya programado con la función RECONOCIMIENTO SEÑAL FLASH habilitada.

# FUNCIONES

Funciones que se pueden obtener al utilizar el teléfono multifunción **bpt** y con los teléfonos estándar

	TELEFONO BPT XT/200	TELEFONO MULTIFRECUENCIA	TELEFONO DECADICO
PROGRAMACION	sí	sí	no posible
LLAMADA URBANA	directo	directo	directo
RECEPCION LLAMADAS URBANAS/TELEFONICAS	sí	sí	sí
ACCESO A LOS SERVICIOS DTMF	sí	sí	no posible
AUTOACTIVACION	 (XVI/200)	 (XVI/200)	 (XVI/200)
ABREPUERTA		R+85	no posible
AUXILIAR/LUZ ESCALERA CENTRALIZADA (salida disponible en el alimentador)		R+88	no posible
AUXILIAR/LUZ ESCALERA INDIVIDUAL (salida disponible en el IT/200) (¹)		R+88	no posible
LLAMADA CONSERJE		R+87	no posible
CAMBIO INTERLOCUTOR		R+80	no posible

(¹) También se puede utilizar la salida AUXILIAR/LUZ ESCALERA INDIVIDUAL con equipos con AUXILIAR/LUZ ESCALERA CENTRALIZADA si se colocan los dip-switch n° 4 y 5 en OFF.



# ÍNDICE

## Instruções para o instalador

Generalidade .....	104
Advertências .....	105
Instalação .....	106
Ligações .....	107
Colocação em função .....	108
Programação .....	109
- Configuração de default .....	109
- Entrada e saída das operações de programação .....	109
- Modalidade segredo de conversação .....	109
- Duração da conversação telefone de porteiro .....	110
- Modalidade analógica ou codificada .....	110
- Código IT/200 no formato bloco/utente e delineamento do modo codificado .....	111
- Código IT/200 no formato progressivo e delineamento do modo codificado .....	111
- Duração comando abertura da porta .....	112
- Modalidade reconhecimento flash ..	112
- Interceptação flash .....	113
- Tipo de monitor para combinar com o telefone .....	113
- Restabelecimento da configuração de default .....	114
Características técnicas .....	115
Tons e ritmos .....	116
- Tons de sinalização .....	116
- Ritmos de chamada .....	116

## Instruções para o utente

Glossário .....	117
Funções .....	118
- Chamada sobre linha urbana .....	118
- Resposta às chamadas que chegam .....	118
- Resposta à chamada da placa botoneira e abertura da porta .....	118
- Auto-inserção na placa botoneira ..	119
- Troca interlocutor .....	119
- Chamada porteiro .....	119
- Comando auxiliar/luz escadas do telefone .....	120
- Desabilitação do aviso acústico quando chega a chamada .....	120
- Acesso aos serviços em DTMF da companhia telefónica .....	120
- Funções que se podem obter com a utilização do telefone <b>bpt</b> e com telefones standard .....	121

---

# GENERALIDADE

A interface telefónica permite a ligação de um aparelho telefónico à linha videoproteiro e telefone de porteiro série 200 e série 100, quer a mesma seja codificada ou não.

Permite a utilização, para além do telefone **bpt**, de normais aparelhos telefónicos “decádicos” ou DTMF, cordless, secretária automática, modem, PABX, etc.

O aparelho consente enviar mesmo chamadas a uma central de portaria de tipo analógico ou digital e de comandar a abertura da porta, luz das escadas centralizada, etc.

O aparelho, realizado num contentor DIN com 8 módulos, é formado por um circuito estampado de base e por uma ficha que contém os dip-switch para a programação e a selecção da tipologia da instalação.

## Funções base

- Acesso directo à linha urbana.
- Ligação ao sistema videoproteiro série 200 com função de auto inserção (se unido ao módulo monitor).
- Ligação ao sistema videoproteiro série 100.
- Ligação ao sistema telefone de porteiro com ou sem segredo de conversação.
- Segredo de conversação para instalações BPT.
- Interface codificada integrada.
- Comunicação telefónica mesmo em ausência de alimentação da rede.
- Chamada diversificada da placa botoneira/linha telefónica.
- Comando abertura porta.
- Comando auxiliar/luz escadas.
- Chamada porteiro.
- Colocação da comunicação em estado de espera (urbana/telefónica).
- Protecção linha telefónica.
- Programação do aparelho através do telefone.
- Alimentação da rede eléctrica.



---

# ADVERTÊNCIAS

Ler com atenção as advertências contidas no seguinte manual porque fornecem importantes indicações que dizem respeito à segurança do uso, da instalação e manutenção.

Depois de ter tirado a embalagem certificar-se da integridade do aparelho.

Os elementos da embalagem (sacos de plástica, poliestireno expando, etc.) não devem ser deixados ao alcance das crianças porque constituem potenciais fontes de perigo.

A eliminação das embalagens deve ser efectuada no respeito das normas vigentes. A execução da instalação deve corresponder às normas de segurança vigentes.

**Não passar os cabos telefónicos em percursos comuns aqueles dos cabos eléctricos.**

Instalar a central em ambientes não poeiros, longe de aparelhagens que possam gerar distúrbios eléctricos de alta frequência, tais como soldadoras, motores eléctricos, fornos a micro-ondas, condicionadores de ar, etc.

E' oportuno prever a montante do alimentador um interruptor apropriado de seccionamento e protecção.

**Antes de ligar o aparelho certificar-se que os dados de chapa sejam correspondentes aqueles da rede de distribuição.**

Este aparelho deverá ser destinado unicamente ao uso para o qual foi expressamente concebido; qualquer uso diverso é considerado impróprio e perigoso.

O fabricante não pode ser considerado responsável por eventuais danos que derivam de usos impróprios, erróneos e irracionais.

Antes de efectuar qualquer operação de limpeza ou de manutenção, desligar o aparelho da rede de alimentação eléctrica, abrindo o interruptor da instalação.

No caso de avarias e/ou mau funcionamento do aparelho desligá-lo da alimentação e não o tocar.

Para a eventual reparação dirigir-se somente a um centro de assistência técnica autorizado pelo fabricante.

O não respeito de quanto acima pode comprometer a segurança do aparelho.

O instalador deve certificar-se que as informações para o utente, onde previsto, estejam presentes sobre os aparelhos.

Todos os aparelhos que fazem parte do equipamento devem ser destinados exclusivamente para o uso para os quais foram concebidos.

# INSTALAÇÃO

O aparelho, realizado num contentor de 8 unidades baixo, pode ser instalado sem cobertura dos bornes em caixas dotadas de guia DIN (EN 50022).

Para as dimensões totais ver a fig. 1A.

Ou então pode ser instalado a parede, com cobertura dos bornes, utilizando a guia DIN em dotação.

Para as dimensões totais ver a fig. 1B.

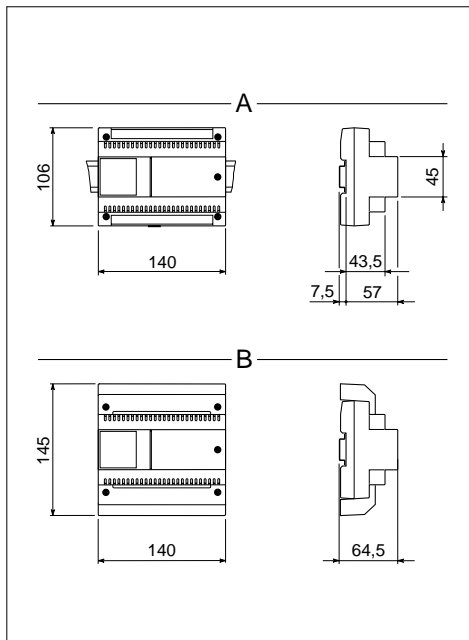

Fig. 1

# LIGAÇÕES

Para ter acesso a la placa de bornes tirar a cobertura dos bornes. Se aconselha de utilizar para a ligação dos telefones, cabo telefónico de 6/10.

Distância máxima entre a interface telefónica e telefone: 100 m.

**NOTA.** O aparelho só deve ser ligado a linhas telefónicas analógicas, não a linhas digitais ISDN.

## Função dos bornes

Placa de bornes T (linha telefónica)

- ae linha urbana
- be linha urbana
- au telefone
- bu telefone

Placa de bornes C (do alimentador)

- 5 massa
- 6 entrada alimentação monitor
- 7 chamada
- 8 áudio da placa botoneira
- 9 áudio a la placa botoneira
- 12 chamada portaria
- 22 auxiliar/luz escadas

Placa de bornes M (ao derivado interno)

- 5 massa
- 6 saída alimentação monitor
- 7 chamada
- 8 áudio da placa botoneira
- 9 áudio a la placa botoneira

Placa de bornes A

- ~ } rede
- ~ }

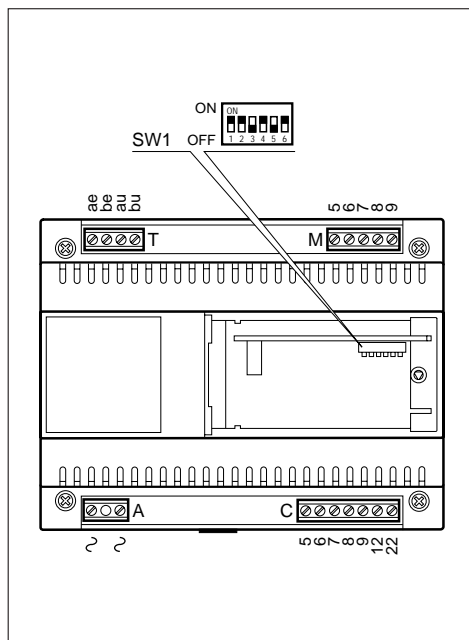

Fig. 2

# COLOCAÇÃO EM FUNÇÃO

O aparelho permite a ligação às seguintes tipologias de instalação BPT:

- telefone porteiro convencional
- telefone porteiro com segredo de conversação
- videoporteiro sistema 100
- videoporteiro sistema 200
- chamada electrónica ou codificada

E' dotado de 6 dip-switch (fig. 2) de posicionar em função da tipologia da instalação (fig. 3).

Além do delineamento dos dip-switch, o aparelho também deve ser programado do telefone para a escolha da tipologia de instalação (ver o capítulo PROGRAMAÇÃO).

O aparelho está predisposto para ser instalado em equipamentos de **videoporteiro sistema 200**.

*ATENÇÃO. Para instalações de porteiros sem segredo de conversação, é necessário programar o aparelho conforme a modalidade indicada na pág. 109.*

## PREDISPOSIÇÃO DIP-SWITCH

DIP-SWITCH	TELEFONE PORTEIRO	VIDEOPORTEIRO SISTEMA 100	VIDEOPORTEIRO SISTEMA 200
SW1	ON	ON	ON
SW2	OFF	OFF	ON
SW3	ON	OFF	ON
SW4	ON	OFF	ON
SW5	OFF	ON	OFF
SW6	ON	OFF	ON

A ligação em ponte **SW1** é posicionada em OFF só durante o processo de PROGRAMAÇÃO.

Fig. 3

# PROGRAMAÇÃO

## Configuração de default

- Modalidade reconhecimento flash: homologado.
- Segredo de conversação: activo.
- Duração conversação telefone porteiro: 60 s.
- Tempo comando abertura porta: 1 s.
- Modalidade: instalações com chamada analógica.
- Código programado para a ligação em instalações com chamada codificada: 80155.
- Interceptação flash: desabilitada.
- Tipo de monitor combinado com o telefone: XV/200.

## Entrada e saída das operações de programação

Para entrar em programação pelo telefone ligado à interface telefónica:



Certificar-se que o auscultador esteja apoiado no suporte.



Levar o dip-switch 1 à posição OFF.

*Durante esta fase podem-se efectuar uma ou diversas programações consecutivas. A inserção dos códigos de programação deve ser executada durante a pausa do tom de programação.*

Para sair da fase de programação:



Levantar o dip-switch 1 à posição ON.



Ao fim do processo activando o telefone se deve ouvir o tom livre da linha telefónica.

## Modalidade segredo de conversação



Levantar o auscultador ou então



premir a tecla viva-voz.

Depois desta operação se deve ouvir um tom duplo de convite à programação.



Digitar **29**.



Digitar **0** para a modalidade instalação sem segredo ou então



**1** para modalidade instalação com segredo.

Ao fim se deve ouvir um triplo tom de confirmação.



Tornar a colocar o auscultador no suporte ou então



premir a tecla viva-voz.

# PROGRAMAÇÃO

## Duração da conversação telefone de porteiro



Levantar o auscultador  
ou então



premir a tecla viva-voz.

Depois desta operação se deve ouvir um tom duplo de convite à programação.

2 7

Digitar 27.



Digitar a duração da conversação (desde 10 até 99 segundos) ex. 20 por 20 segundos.

Ao fim se deve ouvir um triplo tom de confirmação.



Tornar a colocar o auscultador no suporte  
ou então



premir a tecla viva-voz.

**NOTA.** O tempo pode ser variado só para instalações telefone porteiro sem segredo de conversação (ex. com A/200R).

## Modalidade analógica ou codificada

(ver instruções anexas as placas botoneiras digitais)



Levantar o auscultador  
ou então



premir a tecla viva-voz.

Depois desta operação se deve ouvir um tom duplo de convite à programação.

6 2

Digitar 62.

0

Digitar 0 para a modalidade instalação analógica (\*)  
ou então

1

1 para modalidade instalação codificada.

Ao fim se deve ouvir um triplo tom de confirmação.



Tornar a colocar o auscultador no suporte  
ou então



premir a tecla viva-voz.

(\*) Esta programação se torna necessária só no caso que se deseje reconfigurar a interface precedentemente programada com códigos digitais.

# PROGRAMAÇÃO

## Código IT/200 no formato bloco/utente e delineamento do modo codificado

(ver instruções anexas as placas botoneiras digitais)



Levantar o auscultador  
ou então



premir a tecla viva-voz.

Depois desta operação se deve ouvir um tom duplo de convite à programação.



Digitar 60.



Digitar o código de bloco  
(desde 00 até 80), ex. 39.



Digitar o código utente  
(desde 000 até 161), ex. 052.

Ao fim se deve ouvir um triplo tom de confirmação.



Tornar a colocar o auscultador no suporte  
ou então



premir a tecla viva-voz.

## Código IT/200 no formato progressivo e delineamento do modo codificado

(ver instruções anexas as placas botoneiras digitais)



Levantar o auscultador  
ou então



premir a tecla viva-voz.

Depois desta operação se deve ouvir um tom duplo de convite à programação.



Digitar 61.



Digitar o código utente  
(desde 00000 até 13121),  
ex. 01523.

Ao fim se deve ouvir um triplo tom de confirmação.



Tornar a colocar o auscultador no suporte  
ou então



premir a tecla viva-voz.

# PROGRAMAÇÃO

## Duração comando abertura da porta



Levantar o auscultador  
ou então



premir a tecla viva-voz.

Depois desta operação se deve ouvir um tom duplo de convite à programação.

2 8

Digitar 28.



Digitar a duração do comando de abertura porta (desde 01 até 15 segundos), ex. 06 por 6 segundos.

Ao fim se deve ouvir um triplo tom de confirmação.



Tornar a colocar o auscultador no suporte  
ou então



premir a tecla viva-voz.

*NOTA. E' possível explorar esta função só com alimentadores desprovidos de timer centralizados (ex. A/200R ou VA/100.01 estabelecido por comando fechadura eléctrica manual).*

## Modalidade reconhecimento flash



Levantar o auscultador  
ou então



premir a tecla viva-voz.

Depois desta operação se deve ouvir um tom duplo de convite à programação.

2 0

Digitar 20.

0

Digitar 0 para reconhecimento flash homologado  
ou então

1

1 para reconhecimento flash longo.

Ao fim se deve ouvir um triplo tom de confirmação.



Tornar a colocar o auscultador no suporte  
ou então



premir a tecla viva-voz.



# PROGRAMAÇÃO

## Interceptação flash



Levantar o auscultador  
ou então



premir a tecla viva-voz.

Depois desta operação se deve ouvir um tom duplo de convite à programação.

6 3

Digitar 63.

0

Digitar 0 para interceptação flash desabilitado (ligação ao telefone XT/200)  
ou então

1

1 para interceptação flash habilitada (ligação ao telefone DTMF genérico).

Ao fim se deve ouvir um triplo tom de confirmação.



Tornar a colocar o auscultador no suporte

ou então



premir a tecla viva-voz.

## Tipo de monitor para combinar com o telefone



Levantar o auscultador  
ou então



premir a tecla viva-voz.

Depois desta operação se deve ouvir um tom duplo de convite à programação.

6 4

Digitar 64.

0

Digitar 0 quando for utilizado o monitor XV/200 o XVC/200

ou

1

1 quando for utilizado o monitor IMT/200 o IMTC/200.

**NOTA.** Em instalações com derivados inter-nos mistos digitar 1.

Ao fim se deve ouvir um triplo tom de confirmação.



Tornar a colocar o auscultador no suporte

ou então



premir a tecla viva-voz.

---

# PROGRAMAÇÃO

## Restabelecimento da configuração de default



Levantar o auscultador  
ou então



premir a tecla viva-voz.

Depois desta operação se deve ouvir um tom duplo de convite à programação.



Digitar 00.

Ao fim se deve ouvir um triplo tom de confirmação.



Tornar a colocar o auscultador no suporte  
ou então



premir a tecla viva-voz.

---

# CARACTERISTICAS TECNICAS

- Alimentação: 230 Vca - 50 Hz.
- Absorção: 6 VA máx.
- Tensão de saída: 24 V.
- Tensão de chamada 50 V ef./50 Hz.
- Comprimento máx. dos cabos de conexão para cada um dos internos: 100 m (cabo telefónico de 6/10).
- Quantidade de derivados sobre a mesma linha: 5 máx.
- Protecção electrónica que se pode estabelecer.
- Deflexão de frequência: conforme as normas CCITT.
- Habilitação monitor pela duração da conversação.
- Duração máxima conversação telefone porteiro: 99 s.
- Ligação para luz escadas individual (tipo OPEN COLLECTOR 24 Vcc, 50 mA).
- Ligação para chamada porteiro.
- Duração tempo de flash (R) programável.
- Duração tempo de alimentação abertura da porta desde 1 até 15 s.
- Ligação linha urbana mesmo em ausência de alimentação.
- Temperatura de funcionamento: desde 0 °C até +35 °C.
- Humidade relativa: 90% sem condensação.
- Classe de isolamento II.
- Dimensões: módulo de 8 unidades baixo por guia DIN.
- Frequência tons de sinalização: 375 Hz.

O aparelho foi homologado segundo as normas CTR 21 e satisfaz a norma EN 60950, relativa à segurança eléctrica, e a directiva 89/336/EEC modificada com 93/68/EEC, relativas à compatibilidade electromagnética.

Aprovação europeia passada pelo BZT-ETS CERTIFICATION GmbH

## CE 0681 X

# TONS E RITMOS

## Tons de sinalização

FUNÇÃO	TEMPO (segundos)						
	0	1	2	3	4	5	6
Programação	■ ■		■ ■		■ ■		■ ■
Confirmação do fim programação	■ ■ ■		■ ■ ■		■ ■ ■		■ ■ ■
Espera	■ ■				■ ■		
Aviso	■					■	

■ = Nota    \_ = Pausa

## Ritmos de chamada

FUNÇÃO	TEMPO (segundos)						
	0	1	2	3	4	5	6
Urbana	■ ■ ■ ■					■ ■ ■ ■	
Telefone porteiro	■ ■ ■	■ ■ ■				■ ■ ■	■ ■ ■

■ = Nota    \_ = Pausa

---

# GLOSSARIO

## Telefone porteiro

Permite de comunicar com a placa botoneira e de comandar a abertura da porta.

## Default

Com este termo são definidas todas as predisposições ou programação efectuada pelo fabricante.

## Flash (R)

Premindo esta tecla do telefone ligado se predispõe a interface a receber um comando (e não um número telefónico) do teclado.

## Linha urbana

Ligação que permite de comunicar com os utentes da lista telefónica.

## Placa botoneira

Permite ao visitante de efectuar a chamada ao utente e de conversar. Se for dotado de telecâmara, transmite as imagens ao videotelefone em casa.

## Telefone

Aparelho que normalmente permite efectuar e receber telefonemas na linha urbana; com a central IT/200 o telefone pode ser utilizado mesmo como telefone porteiro.

## Telefone “decádico”

Telefone com disco de números; mesmo alguns telefones com teclado são “decádico”: o telefone é “decádico” se, formando um número, ao auscultador se ouvem os impulsos.

## Telefone multi-frequência

Também chamado MF ou DTMF, é o telefone mais moderno. Um telefone é multi-frequência se, formando um número, ao auscultador se ouvem tons.

## Videoporteiro

Para lá das normais funções de telefone porteiro, permite ver no ecrã o visitante que chama da placa botoneira.

# FUNÇÕES

## Chamada sobre linha urbana

É possível dirigir as chamadas no modo habitual, como em cada um dos outros aparelhos.



Levantar o auscultador

ou então



premir a tecla viva voz.



Formar no teclado o número desejado.



Ao fim da conversação tornar a colocar no suporte o auscultador

ou então



premir a tecla viva voz.

## Resposta às chamadas que chegam



Levantar o auscultador

ou então



premir a tecla viva voz.



Ao fim da conversação tornar a colocar no suporte o auscultador

ou então



premir a tecla viva voz.

## Resposta à chamada da placa botoneira e abertura da porta



Levantar o auscultador

ou então



premir a tecla viva voz.



Se se desejasse fazer entrar a pessoa que chama, premir a tecla de abertura da porta (para telefones **bpt**, para outros telefones consultar a tabela recapitulativa).



Colocar no suporte o auscultador

ou então



premir a tecla viva voz.

*NOTA. Se a interface é programada com a função INTERCEPTAÇÃO FLASH desabilitada, não é possível de um telefone standard multi-frequência, efectuar o comando quando se está em comunicação com a linha urbana.*

*O telefone toca com ritmos diferentes em base à proveniência da chamada, se de uma linha urbana ou da placa botoneira. Ver capítulo TONS E RITMOS de toque.*

# FUNÇÕES

## Auto-inserção na placa botoneira

É possível activar a placa botoneira para qualquer uma das seguintes exigências:

- vigilar o externo com audio e vídeo (se a placa botoneira for dotada de telecâmara);
- permutar as placas botoneiras;
- activar a abertura da porta.

*NOTA. A auto-inserção é possível só com a união do módulo vídeo XV/200 e com a instalação videoporteiro livre.*

## Troca interlocutor

Este serviço permite ao utente, em comunicação com uma linha externa ou placa botoneira, de responder a uma chamada proveniente da outra linha mantendo em estado de espera a comunicação em curso.

O interlocutor não em conversação é informado desta condição através de um tom acústico.

*NOTA. Durante a conversação o utente é informado da chamada que está a chegar com um aviso acústico.*

**Para mudar interlocutor durante uma conversação:**



Premir a tecla de comutação telefone porteiro/telefone (para telefones **bpt**, para outros telefones consultar a tabela recapitulativa).

*NOTA. Se a interface é programada com a função INTERCEPTAÇÃO FLASH desabilitada, não é possível de um telefone standard multi-frequência, efectuar o comando quando se está em comunicação com a linha urbana.*

## Chamada porteiro



Levantar o auscultador ou então



premir a tecla viva voz.

Esperar o tom de convite à selecção.



Premir a tecla de chamada porteiro (para telefones **bpt**, para outros telefones consultar a tabela recapitulativa).



Ao fim da conversação tornar a colocar no suporte o auscultador

ou então



premir a tecla viva voz.

*NOTA. Se a interface é programada com a função INTERCEPTAÇÃO FLASH desabilitada, não é possível de um telefone standard multi-frequência, efectuar o comando quando se está em comunicação com a linha urbana.*

# FUNÇÕES

## Comando auxiliar/luz escadas do telefone



Levantar o auscultador  
ou então



premir a tecla viva voz.

Esperar o tom de convite à selecção.



Premir a tecla de chamada auxiliar (para telefones **bpt**, para outros telefones consultar a tabela recapitulativa).



Colocar no suporte o auscultador  
ou então



premir a tecla viva voz.

*NOTA. Se a interface é programada com a função INTERCEPTAÇÃO FLASH desabilitada, não é possível de um telefone DTMF, efectuar o comando quando se está em comunicação com a linha urbana.*

*ADVERTENCIA. Em instalações com segredo de conversação este comando só está disponível se o derivado interno foi chamado da placa botoneira.*

## Desabilitação do aviso acústico quando chega a chamada



Digitar **R83** antes de formar o número telefónico.

Durante todo o tempo da conversação o tom de aviso fica desabilitado.

Utilizar esta função quando for efectuada a ligação com um modem.

Se se deseja obter a desabilitação em automático, acrescenter a série de caracteres **!83**, (ver as instruções do software da conexão telefónica).









## Acesso aos serviços em DTMF da companhia telefónica

O acesso é possível sempre que se configurou a interface como INTERCEPTAÇÃO FLASH desabilitada, enquanto é possível só em comunicação com a linha urbana e na ausência de chamadas da placa botoneira telefone porteiro, quando é configurada como INTERCEPTAÇÃO FLASH habilitada.



# FUNÇÕES

Funções que se podem obter com a utilização do telefone **bpt** e com telefones standard

	TELEFONE BPT XT/200	TELEFONE MULTI-FREQUENCIA	TELEFONE “DECADICO”
PROGRAMAÇÃO	sim	sim	não possível
CHAMADA URBANA	directo	directo	directo
RECEPÇÃO CHAMADAS URBANAS/TELEFONICAS	sim	sim	sim
ACESSO AOS SERVIÇOS TELECOM EM DTMF	sim	sim	não possível
AUTO-INSERÇÃO	 (XVI/200)	 (XVI/200)	 (XVI/200)
ABERTURA PORTA		R+85	não possível
AUXILIAR/LUZ ESCADAS CENTRALIZADO (saída disponível no alimentador)		R+88	não possível
AUXILIAR/LUZ ESCADAS INDIVIDUAL (saída disponível no IT/200) (¹)		R+88	não possível
CHAMADA PORTEIRO		R+87	não possível
MUDANÇA INTERLOCUTOR		R+80	não possível

(¹) E' possível utilizar a saída AUXILIAR/LUZ ESCADAS INDIVIDUAL mesmo em instalações com LUZ ESCADAS CENTRALIZADO delineando os dip-switch n° 4 e 5 em OFF.













