

I ISTRUZIONI PER L'INSTALLAZIONE

SELETTORE D'INGRESSO VSI/200

Questo apparecchio permette la selezione di due posti esterni ed è predisposto per la realizzazione delle seguenti tipologie di impianti:

- Impianti mono o plurifamiliari con più ingressi utilizzando un numero di selettori pari a quello dei posti esterni meno uno.
- Impianti residenziali utilizzando l'apparecchio come selettore di blocco abitativo.

Caratteristiche funzionali del selettore

- Selezione del posto esterno o dell'unità di ripresa supplementare dal monitor in modo sequenziale.
- Protezione di eventuali collegamenti in atto e gestione della segnalazione di occupato, sia se utilizzato come selettore per più posti esterni, sia se utilizzato come selettore di blocco in impianti residenziali (la protezione può essere esclusa inserendo il ponticello SW di fig. 1).

• Il selettore è munito di un amplificatore che rigenera il segnale di chiamata.

• Possibilità di collegare ad una stessa chiamata fino a 3 derivati interni.

• Possibilità di riconoscere il posto esterno da cui proviene la chiamata, tramite nota differenziata per 2 ingressi.

Per ottenere questa funzione collegare il morsetto 8A del selettore VSI/200 al morsetto 8A dell'alimentatore VA/200 (morsettiere B) e togliere il ponticello SW del VA/200 (vedere lo schema di fig. 2).

ATTENZIONE. Questa configurazione esclude la possibilità di realizzare, nello stesso impianto, la chiamata differenziata dal pianerotolo.

Funzione dei morsetti (fig. 1)

Morsettiere B (all'alimentatore o al selettore precedente)

- 3 segnale video
- 4 schermo segnale video ⁽¹⁾
- 5 -17,5V alimentazione
- 6 + posto esterno
- 8 comune chiamata 1
- 8A comune chiamata 2
- 11 audio al monitor
- 12 audio al posto esterno
- 23 pulsante apriporta supplementare
- 14 attivazione posto esterno
- 13 +12V alimentazione
- 16 - elettroserratura
- 24 ingresso segnalazione di occupato

Morsettiere E (al posto esterno n. 1)

Morsettiere F (al posto esterno n. 2 o al selettore successivo)

- 3 segnale video
- 4 schermo segnale video ⁽¹⁾
- 5 -17,5V alimentazione
- 6 + posto esterno
- 8 comune chiamata
- 11 audio al monitor
- 12 audio al posto esterno
- 23 pulsante apriporta supplementare
- 14 attivazione posto esterno
- 13 +12V alimentazione
- 16 - elettroserratura
- 24 uscita segnalazione di occupato

⁽¹⁾ collegamento con cavo coassiale; collegamento con doppino telefonico alle morsettiere B-E-F:

- 3 segnale video positivo
- 4 segnale video negativo

Morsettiere G (servizi)

- 1 ingresso chiamata 1
- 2 ingresso chiamata 2
- 3 ingresso alimentazione 12Vcc
- 4 uscita segnalazione di occupato (per impianti residenziali) reset generale
- 5 abilitazione allo scambio dal selettore successivo
- 7 abilitazione allo scambio dal selettore precedente
- 8 selezione posto esterno

Morsettiere H (servizi)

- 1 uscita chiamata 1
- 2 uscita chiamata 2

Funzione dei ponticelli SW in posizione ON (fig. 1)

- 1 riposizionamento dei selettori a fine scansione dei posti esterni attivati dal monitor (solo il ponticello dell'ultimo selettore deve essere in posizione ON, in tutti i selettori precedenti deve essere in posizione OFF).
- 2 disinserimento protezione chiamate e segnale di occupato.
- 3 ripristino dei posti esterni occupati, negli impianti citofonici, al riposizionamento della cornetta.
- 4-5 attivazione del reset generale (per impianti residenziali).

NOTA. L'apparecchio viene fornito con il ponticello SW1 inserito (impianto con due ingressi).

Caratteristiche tecniche

- Alimentazione: 14,5÷17,5Vcc o 12Vcc.
- Assorbimento: max. 80mA (7mA a riposo).
- Temperatura di funzionamento: da 0 °C a +35 °C.
- Dimensioni: modulo da 12 unità basso (fig. 3).

L'apparecchio può essere installato, senza coprimorsetti, in scatole munite di guida DIN (EN 50022).

Per le dimensioni di ingombro vedere la fig. 3A.

Oppure può essere installato a parete utilizzando la guida DIN in dotazione ed applicando il coprimorsetti.

Per le dimensioni di ingombro vedere la fig. 3B.

GB INSTALLATION INSTRUCTIONS

VSI/200 ENTRANCE SELECTOR

This unit permits the selection of two entry panels and is configured to create the following systems:

- Single or multi-family systems with several entrances using the same number of selectors as there are entry panels minus one.
- Residential systems using the unit as a block selector.

Operating characteristics

- Sequential selection of entry panel or supplementary camera by the monitor.
- Protection of any connections installed and management of the engaged signal irrespective of whether the unit is used as a selector for several entry panels or as a block selector in residential systems (the protection may be disabled by connecting jumper SW2, figure 1).
- The selector is equipped with an amplifier which regenerates the call signal.
- Possibility of connecting up to

three internal units to the same call.

- Possibility of trading the origin of an external call by means of different tones which correspond to two different entry panels.

To obtain this function: connect terminal 8A of VSI/200 selector to terminal 8A of VA/200 power supplier (terminal board B) and remove the jumper SW from VA/200 power supplier as shown in figure 2.

WARNING. A differentiated landing call tone is not available in this configuration.

Function of each terminal, figure 1 Terminal block B (to power supplier or preceding selector)

- | | | |
|----|-------------------------------|-------|
| 3 | video signal |] (¹) |
| 4 | video signal shield | |
| 5 | 17,5 supply voltage |] (¹) |
| 6 | to entry panel | |
| 8 | call 1 common |] (¹) |
| 8A | call 2 common | |
| 11 | audio signal to monitor |] (¹) |
| 12 | audio signal to entry panel | |
| 23 | auxiliary door release button |] (¹) |
| 14 | entry panel activation | |
| 13 | 12V supply voltage to |] (¹) |
| 16 | door release solenoid | |
| 24 | engaged signal input | |

Terminal block E (to entry panel no. 1)

Terminal block F (to entry panel no. 2 or subsequent selector)

- | | | |
|----|-------------------------------|-------|
| 3 | video signal |] (¹) |
| 4 | video signal shield | |
| 5 | 17,5V supply voltage |] (¹) |
| 6 | to entry panel | |
| 8 | call common |] (¹) |
| 11 | audio signal to monitor | |
| 12 | audio signal to entry panel |] (¹) |
| 23 | auxiliary door release button | |
| 14 | entry panel activation |] (¹) |
| 13 | 12V supply voltage to | |
| 16 | door release solenoid |] (¹) |
| 24 | engaged signal output | |

(¹) coaxial cable connection; twisted pair connection to terminal blocks B-E-F:

- | | |
|---|-----------------------|
| 3 | positive video signal |
| 4 | negative video signal |

Terminal block G (services)

- | | |
|---|---|
| 1 | call 1 input |
| 2 | call 2 input |
| 3 | 12V DC power input |
| 4 | engaged signal output (for residential systems) |
| 5 | general reset |
| 6 | changeover enable-next selector |
| 7 | changeover enable-previous selector |
| 8 | entry panel selection |

Terminal block H (services)

- | | |
|---|---------------|
| 1 | call 1 output |
| 2 | call 2 output |

SW jumper functions, in ON position, figure 1

- 1 repositioning of selectors following scanning of entry panels activated by the monitor (only the jumper of the last selector must be set in position ON while all preceding selectors must be set to OFF).
- 2 deactivation of call protection and engaged signal.

- 3 resetting of engaged entry panels on audio entry systems by replacing the handset.

- 4-5 activation of general reset (on residential systems).

NOTE. The selector is supplied with SW1 jumper wired in (installation with 2 entry panels).

Technical features

- Supply voltage: 14,5÷17,5VDC or 12VDC.
 - Current demand: max. 80mA (7mA quiescent).
 - Working temperature range: from 0 °C to +35 °C.
 - Dimensions: 12 DIN units, low profile module, figure 3.
- The unit can be installed without terminal covers, in boxes fitted with DIN guide (EN 50022). See figure 3A for overall dimensions.
- Alternatively, it can be wall-mounted using the DIN guide provided, and applying the terminal cover. See figure 3B for overall dimensions.

D INSTALLATIONS-ANLEITUNG

EINGANGSWÄHLER VSI/200

Mit diesem Gerät können 2 Außenstationen angewählt werden. Es ist für die folgenden Anlagentypologien geeignet:

- Ein- und Mehrfamilienhausanlagen mit mehreren Eingängen unter Verwendung einer Anzahl von Eingangswählern, die der Anzahl der Außenstationen minus entspricht.
- Wohnanlagen mit mehreren Wohngebäuden als Eingangswähler des Wohnblocks.

Funktionseigenschaften des Eingangswählers

- Sequentielle Anwahl der Außenstation oder zusätzlichen Kamera über den Monitor.
 - Schutz eventuell laufender Verbindungen und Steuerung der Besetzanzeige in der Anwendung als Eingangswähler für mehrere Außenstationen und als Block-Eingangswähler in Wohnanlagen (der Schutz kann durch Schaltung der Brücke SW2, Abb. 1, abgeschaltet werden).
 - Der Eingangswähler ist mit einem Verstärker ausgestattet, der den Ruftönen erzeugt.
 - Zusammenlegen von bis zu 3 Sprechgarnituren in einem Anruf möglich.
 - Außenstation der Herkunft des Anrufes durch verschiedene Ruftöne für zwei Eingänge erkennbar.
- Für diese Funktion die Anschlußklemme 8A des Eingangswählers VSI/200 an die Anschlußklemme 8A des Netzgerätes VA/200

(Klemmleiste B) anschließen und die Brücke SW von VA/200 entfernen (siehe Schaltplan aus Abb. 2). **ACHTUNG.** Diese Konfiguration schließt den differenzierten Etagenruf innerhalb derselben Anlage aus.

Belegung der Klemmleisten (Abb. 1)

Klemmleiste B (am Netzgerät oder am vorangehenden Eingangswähler)

- | | | |
|----|-------------------------------|-------|
| 3 | Videosignal |] (¹) |
| 4 | Videosignalabschirmung | |
| 5 | 17,5 Stromversorgung |] (¹) |
| 6 | Außenstation | |
| 8 | Gemeinsamer Anruf 1 |] (¹) |
| 8A | Gemeinsamer Anruf 2 | |
| 11 | Audio zum Monitor |] (¹) |
| 12 | Audio zur Außenstation | |
| 23 | Zusätzliche Türöffnertaste |] (¹) |
| 14 | Einschaltung der Außenstation | |
| 13 | 12VStromversorgung |] (¹) |
| 16 | Türöffner | |
| 24 | Eingang für Besetzanzeige | |

Klemmleiste E (an der Außenstation 1)

Klemmleiste F (an der Außenstation 2 oder am nächsten Eingangswähler)

- | | | |
|----|-------------------------------|-------|
| 3 | Videosignal |] (¹) |
| 4 | Videosignalabschirmung | |
| 5 | 17,5V Stromversorgung |] (¹) |
| 6 | Außenstation | |
| 8 | Gemeinsamer Anruf |] (¹) |
| 11 | Audio zum Monitor | |
| 12 | Audio zur Außenstation |] (¹) |
| 23 | Zusätzliche Türöffnertaste | |
| 14 | Einschaltung der Außenstation |] (¹) |
| 13 | 12VStromversorgung | |
| 16 | Türöffner |] (¹) |
| 24 | Ausgang für Besetzanzeige | |

(¹)Anschluß mit Koaxialkabel; Anschluß mit Telefonkabel zum Klemmleisten B-E-F:

- | | |
|---|-----------------------|
| 3 | Positives Videosignal |
| 4 | Negatives Videosignal |

Klemmleiste G (Betrieb)

- | | |
|---|--|
| 1 | Eingang Anruf 1 |
| 2 | Eingang Anruf 2 |
| 3 | Eingang Stromversorgung 12VDC |
| 4 | Ausgang für Besetzanzeige (für Wohnanlagen) |
| 5 | Betriebreset |
| 6 | Freigabe zur Weiche zum nächsten Eingangswähler |
| 7 | Freigabe zur Weiche zum vorangehenden Eingangswähler |
| 8 | Anwahl der Außenstation |

Klemmleiste H (Betrieb)

- | | |
|---|-----------------|
| 1 | Ausgang Anruf 1 |
| 2 | Ausgang Anruf 2 |

Funktion der Steckbrücken SW auf Position ON (Abb. 1)

- 1 Neupositionierung der Eingangswähler nach Absuchen der vom Monitor eingeschalteten Außenstationen (nur die Steckbrücke des letzten Eingangswählers muß auf ON geschaltet sein, an allen vorangehenden Eingangswählern soll sie auf OFF geschaltet sein).

- 2 Abschaltung des Mithörschutzes und der Besetztanzeige.
- 3 Rückstellung der besetzten Außenstation an Haussprechanlagen bei Auflegen des Hörers.
- 4-5 Betriebsreset (für Wohnanlagen).

ANMERKUNG. Der Wähler ist mit Brücke SW1 schon eingesteckt geliefert (Anlage mit 2 Außenstationen).

Technische Daten

- Stromversorgung: 14,5÷17,5V DC oder 12V DC.
- Stromaufnahme: max. 80mA (7mA Ruhestrom).
- Betriebstemperatur: 0 °C bis +35 °C.
- Abmessungen: 12 DIN-Einheit, flach (Abb. 3).
Das Gerät kann ohne Klemmenabdeckungen in DIN-Montageschächten (EN50022) installiert werden.
Für die Sperrmaße siehe Abb. 3A.
Das Gerät kann auch unter Anwendung der im Lieferumfang befindlichen DIN-Montage und der Klemmenabdeckungen an der Wand installiert werden.
Für die Sperrmaße siehe Abb. 3B.

F INSTRUCTIONS POUR L'INSTALLATION

SELECTEUR D'ENTREE VSI/200

Cet appareil permet de sélectionner 2 postes extérieurs et il est prédisposé pour la réalisation des typologies d'installations suivantes:

- Installations pour pavillon ou pour immeuble avec plusieurs entrées en utilisant un nombre de sélecteurs équivalent à celui des postes extérieurs moins un.
- Installations résidentielles en utilisant l'appareils comme sélecteur de bloc d'habitation.

Caractéristiques fonctionnelles du sélecteur

- Sélection du poste extérieur ou de l'unité de prise de vue supplémentaire à partir du moniteur - mode séquentiel.
- Protection de liaisons éventuelles en cours et gestion de la signalisation d'occupé, soit si utilisé comme sélecteur pour plusieurs postes extérieurs, soit si utilisé comme sélecteur de bloc dans des installations résidentielles (la protection peut être exclue en insérant le cavalier SW2 de la fig. 1).
- Le sélecteur est muni d'un amplificateur qui régénère le signal d'appel.
- Possibilité de relier à un même appel jusqu'à 3 dérivés internes.
- Possibilité de reconnaître le poste extérieur d'où provient l'appel, grâce à une note différenciée

pour 2 entrées.
Pour obtenir cette fonction, relier la borne 8A du sélecteur VSI/200 à la borne 8A de l'alimentation VA/200 (borniers B) et enlever le cavalier SW du VA/200 (voir le schéma de la fig. 2).
ATTENTION. Cette configuration exclut la possibilité de réaliser, dans la même installation, l'appel différencié depuis le palier.

Fonction des bornes (fig. 1)

- Bornier B (a l'alimentateur ou au sélecteur précédent)**
- | | | |
|----|--|-------|
| 3 | signal vidéo |] (¹) |
| 4 | blindage signal vidéo | |
| 5 | ⊖ 17,5V alimentation | |
| 6 | ⊕ poste extérieur | |
| 8 | commun appel 1 | |
| 8A | commun appel 2 | |
| 11 | audio au moniteur | |
| 12 | audio au poste extérieur | |
| 23 | bouton-poussoir ouvre-porte supplémentaire | |
| 14 | activation poste extérieur | |
| 13 | ⊕ 12V alimentation | |
| 16 | ⊖ gâche électrique | |
| 24 | entrée signalisation d'occupée | |

Bornier E (au poste extérieur 1)

Bornier F (au poste extérieur 2 ou au sélecteur successif)

- | | | |
|----|--|-------|
| 3 | signal vidéo |] (¹) |
| 4 | blindage signal vidéo | |
| 5 | ⊖ 17,5V alimentation | |
| 6 | ⊕ poste extérieur | |
| 8 | commun appel | |
| 11 | audio au moniteur | |
| 12 | audio au poste extérieur | |
| 23 | bouton-poussoir ouvre-porte supplémentaire | |
| 14 | activation poste extérieur | |
| 13 | ⊕ 12V alimentation | |
| 16 | ⊖ gâche électrique | |
| 24 | sortie signalisation d'occupée | |

(¹) connexion avec câble coaxial; connexion avec paire torsadé aux borniers B-E-F:

- | | |
|---|----------------------|
| 3 | signal vidéo positif |
| 4 | signal vidéo négatif |

Bornier G (services)

- | | |
|---|---|
| 1 | entrée appel 1 |
| 2 | entrée appel 2 |
| 3 | entrée alimentation 12Vcc |
| 4 | sortie signalisation d'occupé (pour installations résidentielles) |
| 5 | reset général |
| 6 | habilitation à l'échange au sélecteur successif |
| 7 | habilitation à l'échange à partir du sélecteur précédent |
| 8 | sélection poste extérieur |

Bornier H (services)

- | | |
|---|----------------|
| 1 | sortie appel 1 |
| 2 | sortie appel 2 |

Fonctions des cavaliers SW sur la position ON (fig. 1)

- | | |
|---|---|
| 1 | repositionnement des sélecteurs au terme du balayage des postes extérieurs activés par le moniteur (seule le cavalier du dernier sélecteur doit être sur la position ON, pour tous les sélecteurs précédents il doit être sur la position OFF). |
|---|---|

- 2 désinsertion protection appels et signal d'occupée.
- 3 réactivation des postes extérieurs occupés, dans des installations portier électronique, lors du remplacement du récepteur
- 4-5 activation du reset général (pour les installations résidentielles).

NOTE. Le sélecteur est fourni avec le cavalier SW1 inséré (installation avec 2 postes extérieurs).

Caractéristiques techniques

- Alimentation: 14,5÷17,5Vcc ou 12V cc.
- Consommation: 80mA maxi (7mA à repos).
- Température de fonctionnement: de 0 °C à +35 °C.
- Dimensions: module bas de 12 unités (fig. 3).
L'appareil peut être installé, sans cache-bornes, dans des boîtiers équipés d'un rail DIN (EN 50022).
En ce qui concerne les dimensions d'encombrement, voir la fig. 3A.
Ou bien peut être installé sur un mur à l'aide du rail DIN fourni, et en appliquant le cache-bornes. En ce qui concerne les dimensions d'encombrement, voir la fig. 3B.

E INSTRUCCIONES PARA LA INSTALACION

SELECTOR DE ENTRADA VSI/200

Este aparato permite seleccionar dos placas exteriores y puede utilizarse para la realización de los siguientes tipos de equipos:

- Equipos mono o plurifamiliares con varias entradas, utilizando un número de selectores igual al de placas exteriores menos uno.
- Equipos residenciales, utilizando el aparato como selector de bloque de viviendas.

Características funcionales del selector

- Selección de la placa exterior o de la cámara suplementaria desde el monitor en modo secuencial.
- Protección de eventuales conexiones en curso y control de la señalización de ocupado, ya sea que se lo utilice como selector para varias placas exteriores o como selector de bloque en equipos residenciales (la protección puede excluir montando el puente SW2 de la fig. 1).
- El selector está dotado de un amplificador que regenera la señal de llamada.
- Posibilidad de conectar a una misma llamada hasta 3 derivados internos.
- Posibilidad de reconocer la placa exterior del cual proviene la llamada, mediante nota diferenciada para dos entradas

Para obtener esta función, conectar el borne 8A del selector VSI/200 al borne 8A del alimentador VA/200 (bornera B) y quitar el puente SW del VA/200 (ver el esquema de la fig. 2).
ATENCIÓN. Esta configuración excluye la posibilidad de realizar en el mismo equipo la llamada diferenciada desde el rellano.

Funciones de los bornes (fig. 1)

- Bornera B (al alimentador o al selector anterior)**
- | | | |
|----|-----------------------------------|-------|
| 3 | señal de vídeo |] (¹) |
| 4 | pantalla señal de vídeo | |
| 5 | ⊖ 17,5 alimentación | |
| 6 | ⊕ placa exterior | |
| 8 | común llamada 1 | |
| 8A | común llamada 2 | |
| 11 | audio al monitor | |
| 12 | audio a la placa exterior | |
| 23 | pulsador abrepuerta suplementario | |
| 14 | activación placa exterior | |
| 13 | ⊕ 12V alimentación | |
| 16 | ⊖ cerradura eléctrica | |
| 24 | entrada señalización de ocupado | |

Bornera E (a la placa exterior 1)

Bornera F (a la placa exterior 2 o al selector siguiente)

- | | | |
|----|-----------------------------------|-------|
| 3 | señal de vídeo |] (¹) |
| 4 | pantalla señal de vídeo | |
| 5 | ⊖ 17,5V alimentación | |
| 6 | ⊕ placa exterior | |
| 8 | común llamada | |
| 11 | audio al monitor | |
| 12 | audio a la placa exterior | |
| 23 | pulsador abrepuerta suplementario | |
| 14 | activación placa exterior | |
| 13 | ⊕ 12V alimentación | |
| 16 | ⊖ cerradura eléctrica | |
| 24 | salida señalización de ocupado | |

(¹) conexión con cable coaxial; conexión con cable doble telefónico a las borneras B-E-F:

- | | |
|---|-------------------------|
| 3 | señal de vídeo positiva |
| 4 | señal de vídeo negativa |

Bornera G (servicios)

- | | |
|---|---|
| 1 | entrada llamada 1 |
| 2 | entrada llamada 2 |
| 3 | entrada alimentación 12Vcc |
| 4 | salida señalización de ocupado (para equipos residenciales) |
| 5 | puesta en cero general |
| 6 | habilitación para la conmutación al selector siguiente |
| 7 | habilitación para la conmutación al selector anterior |
| 8 | selección placa exterior |

Bornera H (servicios)

- | | |
|---|------------------|
| 1 | salida llamada 1 |
| 2 | salida llamada 2 |

Funcione de los puentes SW en posición ON (fig. 1)

- | | |
|---|---|
| 1 | reubicación de los selectores al final de la exploración de las placas exteriores activadas por el monitor (solo el puente del último selector debe estar en posición ON; en todos los selectores anteriores debe estar en posición OFF). |
|---|---|

- 2 desactivación de la protección de llamadas y señal de ocupado.
- 3 restablecimiento de las placas exteriores ocupadas, en equipos de portero electrónico, al colgarse el auricular.
- 4-5 activación de la puesta en cero general (para equipos residenciales).

NOTA. El selector se provee con el puente SW1 insertado (equipo con 2 placas exteriores).

Características técnicas

- Alimentación: 14,5÷17,5Vcc ó 12Vcc.
- Consumo: máx. 80mA (7mA en reposo).
- Temperatura de funcionamiento: de 0 °C a +35 °C.
- Dimensiones: módulo de 12 unidades bajo (fig. 3).

El aparato se puede instalar, sin proteger conectores, en cajas que dispongan de guía DIN (EN 50022).

Para las dimensiones del bulto consultar la fig. 3A.

También se puede instalar en la pared mediante la utilización de la guía DIN que se entrega junto al aparato y con la aplicación de los protege conectores.

Para las dimensiones del bulto consultar la fig. 3B.

P INSTRUÇÕES PARA A INSTALAÇÃO

SELECTOR DE ENTRADA VSI/200

Este aparelho permite a selecção de 2 placas botoneiras e é preparado para a realização das seguintes tipologias de instalação:

- Instalações mono ou plurifamiliares com mais entradas utilizando um número de selectores igual ao das placas botoneiras menos uma.
- Em instalações residenciais utilizando o aparelho como selector de bloco de habitações.

Características funcionais do selector

- Selecção da placa botoneira ou da telecâmara suplementar do monitor de maneira sequencial.
- Protecção de eventuais ligações em acto e gestão da sinalização de ocupado, se utilizado como selector para mais placas de botoneiras, ou se utilizado como selector de bloco em instalações residenciais (a protecção pode ser excluída introduzindo a ponte SW2, fig. 1).
- O selector possui um amplificador que regenera o sinal de chamada.
- Possibilidade de ligar a uma mesma chamada até 3 monitores.
- Possibilidade de reconhecer a placa botoneira de onde procede

a chamada, através de nota diferenciada para 2 entradas. Para obter esta função ligar o borne 8A do selector VSI/200 ao borne 8A do alimentador VA/200 (placas de bornes B) e tirar a ponte SW do VA/200.

Neste caso não é possível realizar a ligação para uma eventual chamada do patamar.

Função dos bornes (fig. 1)

Placa de bornes B (para o alimentador ou para o selector anterior)

- | | | |
|----|-------------------------------------|-------|
| 3 | sinal vídeo |] (1) |
| 4 | massa sinal vídeo | |
| 5 | ⌋ 17,5V alimentação | |
| 6 | ± placa botoneira | |
| 8 | comum chamada 1 | |
| 8A | comum chamada 2 | |
| 11 | audio para o monitor | |
| 12 | audio para a placa botoneira | |
| 23 | botão abertura da porta suplementar | |
| 14 | activação placa botoneira | |
| 13 | ⌋ 12V alimentação | |
| 16 | ⌋ fechadura eléctrica | |
| 24 | entrada sinalização ocupado | |

Placa de bornes E (para a placa botoneira)

Placa de bornes F (para a placa botoneira ou para o selector seguinte)

- | | | |
|----|-------------------------------------|-------|
| 3 | sinal vídeo |] (1) |
| 4 | massa sinal vídeo | |
| 5 | ⌋ 17,5V alimentação | |
| 6 | ± placa botoneira | |
| 8 | comum chamada | |
| 11 | audio para o monitor | |
| 12 | audio para a placa botoneira | |
| 23 | botão abertura da porta suplementar | |
| 14 | activação placa botoneira | |
| 13 | ⌋ 12V alimentação | |
| 16 | ⌋ fechadura eléctrica | |
| 24 | entrada sinalização ocupado | |

(1) Ligação com cabo coaxial; ligação com par telefónico a las placas de bornes B-E-F:

- | | |
|---|----------------------|
| 3 | sinal vídeo positivo |
| 4 | sinal vídeo negativo |

Placa de bornes G (serviços)

- 1 entrada chamada 1
- 2 entrada chamada 2
- 3 entrada alimentação 12Vcc
- 4 saída sinalização de ocupado (para instalações residenciais)
- 5 reset geral
- 6 activação para comutação ao selector seguinte
- 7 activação para comutação ao selector anterior
- 8 seleção placa botoneira

Placa de bornes H (serviços)

- 1 saída chamada 1
- 2 saída chamada 2

Função das pontes SW na posição ON (fig. 1)

- 1 reposição dos selectores no final da sequência das placas botoneiras activadas pelo monitor (só a ponte do último selector deve ser posicionado em ON, em todos os selectores anteriores deve estar na posição OFF)

- 2 desactivação protecção chamadas e sinal de ocupado
- 3 restabelecimento das placas botoneiras ocupadas, em instalações de telefone de porteiro, ao pousar o auscultador
- 4-5 activação do reset geral (para instalações residenciais).

NOTA. O aparelho é fornecido com a ponte SW1 inserida (instalação com 2 entradas).

Características técnicas

- Alimentação: 14,5÷17,5 Vcc ou 12 Vcc.
- Consumo: 80 mA máx (7 mA em descanso).
- Temperatura de funcionamento: desde 0 °C até + 35 °C.
- Dimensões: módulo de 12 unidades baixo por guia DIN (fig. 3).

O alimentador pode ser instalado, sem cobertura dos bornes, em caixas dotadas da guia DIN (EN 50022).

Para as dimensões máximas extremas ver a fig. 3A.

Ou então pode ser instalado a parede utilizando a guia DIN em dotação e aplicando a cobertura dos bornes.

Para as dimensões máximas extremas ver a fig. 3B.

SCHEMI D'IMPIANTO

CON CAVO COASSIALE	pag. 6 ÷ 17
CON DOPPIO TELEFONICO	pag. 18 ÷ 19

INSTALLATION WIRING DIAGRAMS

WITH COAXIAL CABLE	page 6 ÷ 17
WITH TWISTED PAIR	page 18 ÷ 19

ANLAGENPLÄNE

MIT KOAXIALKABEL	Seite 6 ÷ 17
MIT TELEFONKABEL	Seite 18 ÷ 19

SCHEMAS D'INSTALLATION

AVEC CABLE COAXIAL	page 6 ÷ 17
AVEC PAIRE TORSADE	page 18 ÷ 19

ESQUEMAS DE INSTALACIONES

CON CABLE COAXIAL	pag. 6 ÷ 17
CON CABLE DOBLE TELEFONICO	pag. 18 ÷ 19

ESQUEMAS DE INSTALAÇÃO

COM CABO COAXIAL	pag. 6 ÷ 17
COM PAR TVHV	pag. 18 ÷ 19

SEZIONE DEI CONDUTTORI WIRE CROSS-SECTION LEITER QUERSCHNITT SECTION DES CONDUCTEURS SECCION DE LOS CONDUCTORES SECÇÃO DOS CONDUTORES

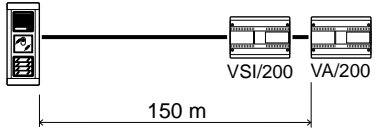

B E-F	VCM/130	VCM/130NPI	COLORE - COLOUR - FARBE COULEUR - COLOR - COR
	mm ²	mm ²	
3	0,28 (*)	0,28 (*)	
4	0,28 (*)	0,28 (*)	
5	0,5	0,5	
6	0,75	0,75	
8	1	1	
11	0,5	0,5	
12	0,5	0,5	
23	1	1	
14	0,5	0,5	
13	1	1	
16	1,5	1,5	
24	0,5	0,5	
(*) Ø 0,6 mm			
G			
5	0,5		
6	0,5		
7	0,5		
8	0,5		

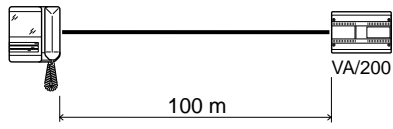

C	VCM/60	VCM/60NPI	COLORE - COLOUR - FARBE COULEUR - COLOR - COR
	mm ²	mm ²	
5	1	1,5	
6	1	1	
8	0,5	0,5	
9	0,5	0,5	
D			
3	0,28 (*)	0,28 (*)	
4	0,28 (*)	0,28 (*)	
7	0,5	0,5	
(*) Ø 0,6 mm			

CP: Pulsante di chiamata dal pianerottolo.
Personal door-bell button.
Taste zum Anrufen von der Etage.
Bouton d'appel porte-palrière.
Pulsador de llamada desde el rellano.
Botão de chamada do patamar.

AE: Pulsante ausiliario apriporta.
Auxiliary door-lock release button.
Turöffnertaste (Auxiliary/Service).
Bouton gâche intérieure.
Pulsador auxiliar abrepuerta.
Botão auxiliar de abertura de porta.

SE 8008.1

IMPIANTO MONO O PLURIFAMILIARE CON 2 INGRESSI, DI CUI UNO CON SOLA FONIA (SEGNAZIONE D'INGRESSO OCCUPATO).

SINGLE OR MULTI-FLAT INSTALLATION USING 2 ENTRY PANELS ONE OF WHICH IS PHONIC ONLY (ENGAGED SIGNAL INDICATOR).

EIN- ODER MEHRFAMILIENHAUSANLAGE MIT 2 AUßENSTATIONEN, DAVON EINER OHNE AUDIOÜBERWACHUNG (MIT BESETZTANZEIGE).

INSTALLATION POUR PAVILLON OU IMMEUBLE A 2 ENTREES DONT UNE AVEC PHONIE UNIQUEMENT (INDICATION DE LIGNE OCCUPEE).

EQUIPO MONO O MULTIFAMILIAR CON 2 ENTRADAS DE LAS QUALES UNA SOLO CON FONIA (SEÑALACION DE ENTRADA OCUPADA).

INSTALAÇÃO MONO O PLURIFAMILIAR COM 2 ENTRADAS, COM UMA TELECAMARA (COM SINALIZAÇÃO DE CHAMADA OCUPADA).

SE 8008.1-A

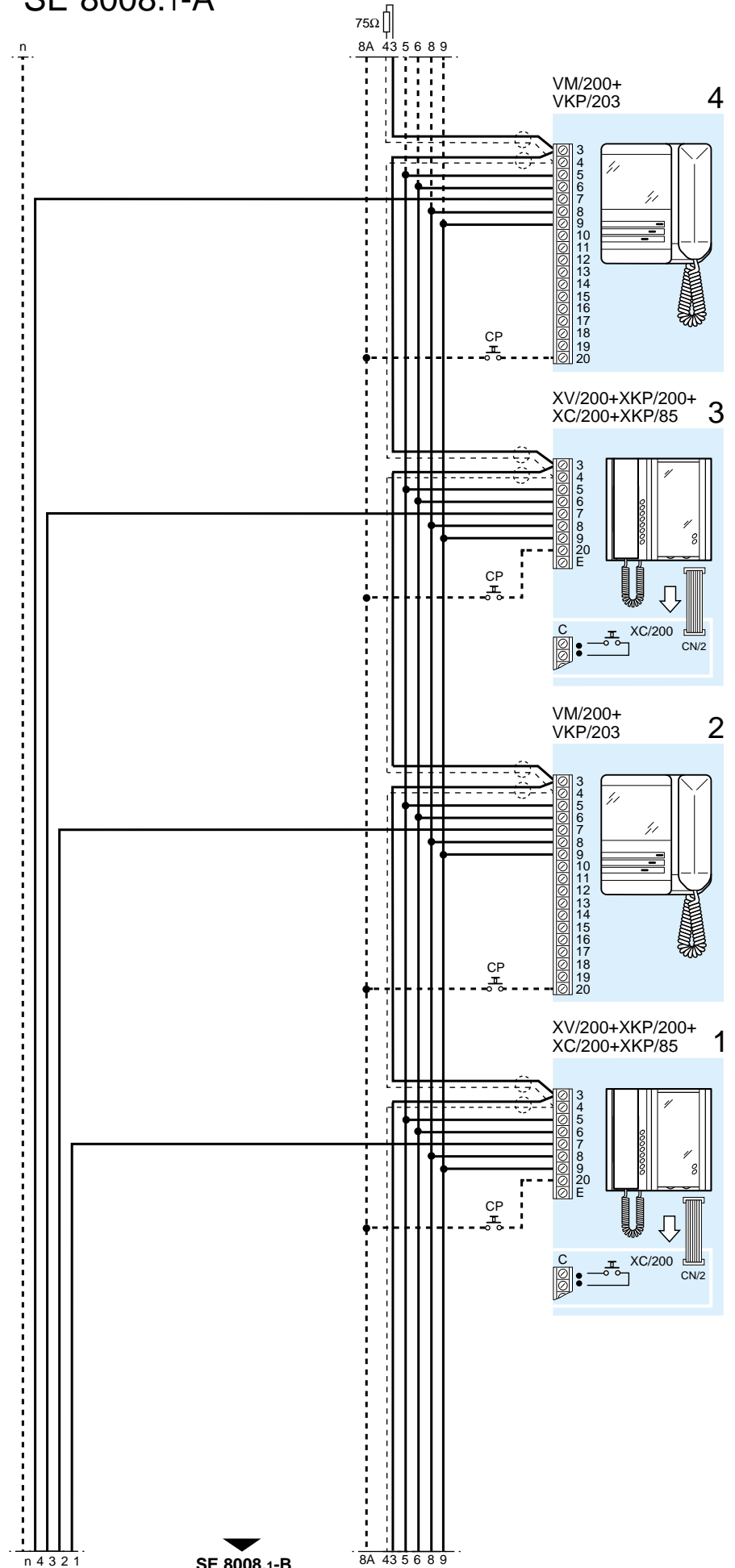

SE 8008.1-B

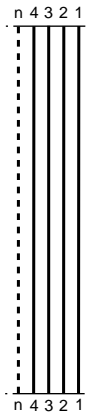

SE 8008.1-A

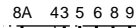

1

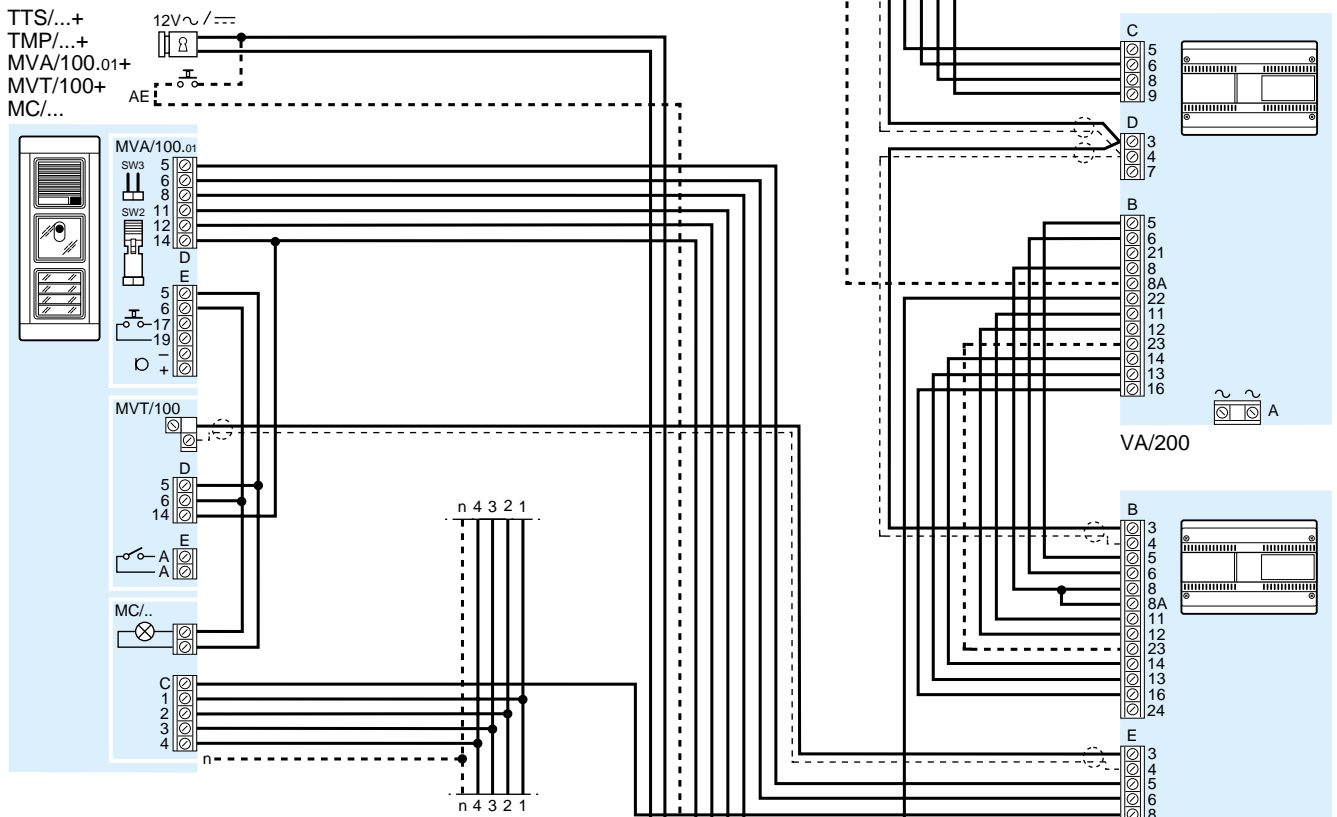

2

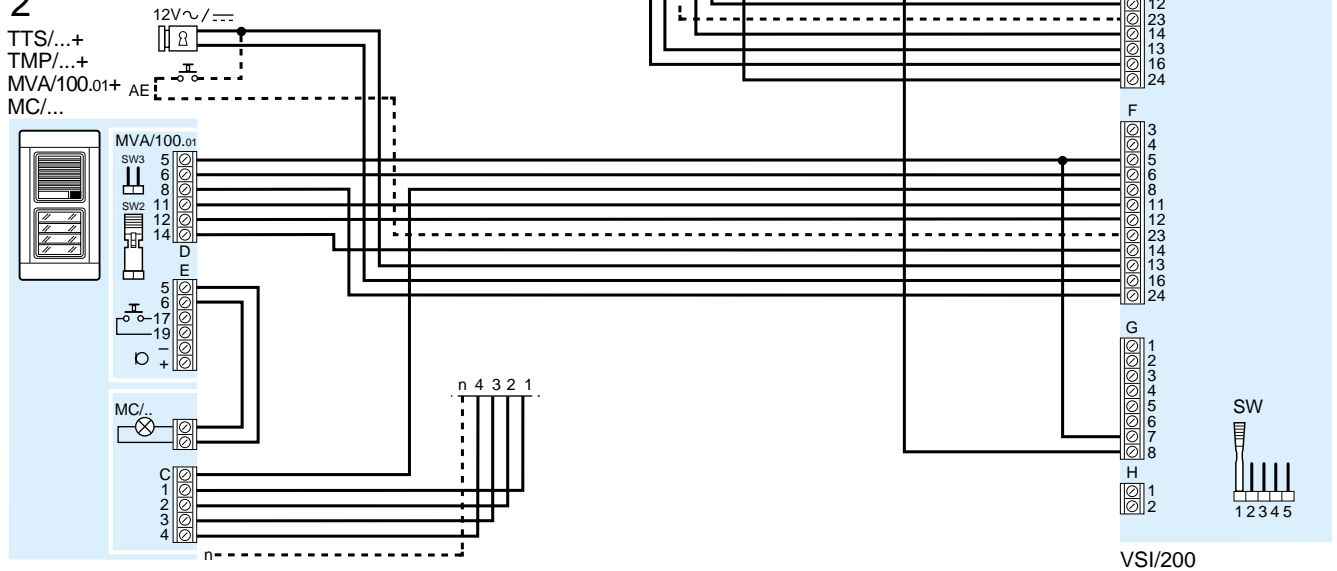

SE 8008.2

IMPIANTO MONO O PLURIFAMILIARE CON 2 INGRESSI, DI CUI UNO CON SOLA FONIA (SEGNAZIONE D'INGRESSO OCCUPATO).

SINGLE OR MULTI-FLAT INSTALLATION USING 2 ENTRY PANELS ONE OF WHICH IS PHONIC ONLY (ENGAGED SIGNAL INDICATOR).

EIN- ODER MEHRFAMILIENHAUSANLAGE MIT 2 AUßENSTATIONEN, DAVON EINER OHNE AUDIOÜBERWACHUNG (MIT BESETZTANZEIGE).

INSTALLATION POUR PAVILLON OU IMMEUBLE A 2 ENTREES DONT UNE AVEC PHONIE UNIQUEMENT (INDICATION DE LIGNE OCCUPEE).

EQUIPO MONO O MULTIFAMILIAR CON 2 ENTRADAS DE LAS QUALES UNA SOLO CON FONIA (SEÑALACION DE ENTRADA OCUPADA).

INSTALAÇÃO MONO O PLURIFAMILIAR COM 2 ENTRADAS, COM UMA TELECAMARA (COM SINALIZAÇÃO DE CHAMADA OCUPADA).

SE 8008.2-A

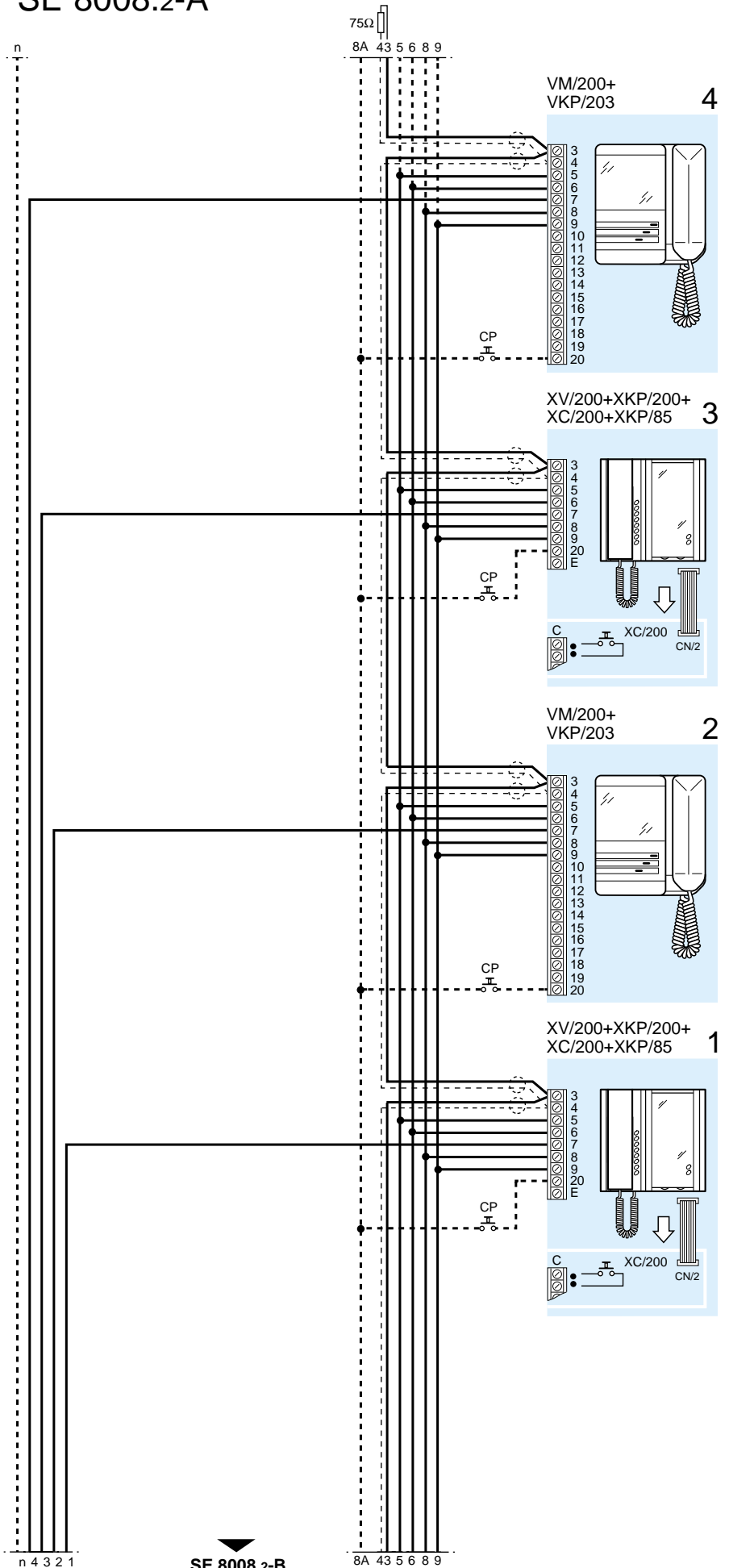

SE 8008.2-B

SE 8008.2-B

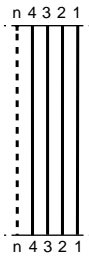

SE 8008.2-A

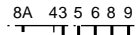

1
HPV/1+
HAV/200+
...KHPS+
...HPP/6+
...HTS+
KHSO

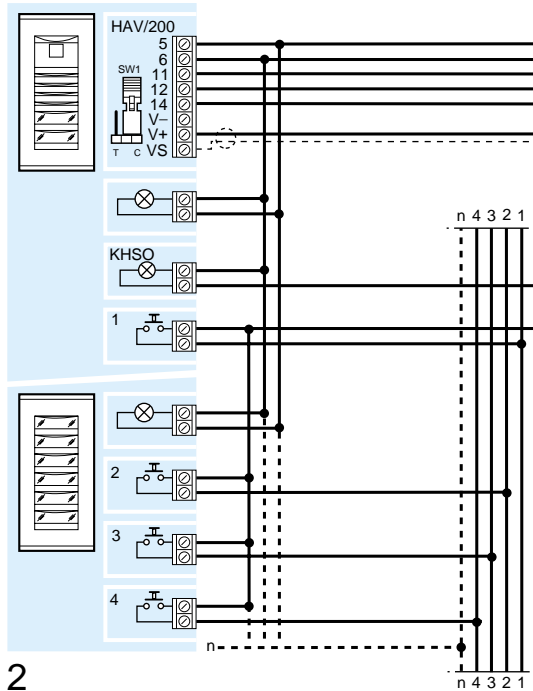

2
HPC/1+
HA/200+
...KHPS+
...HPP/6+
...HTS+
KHSO

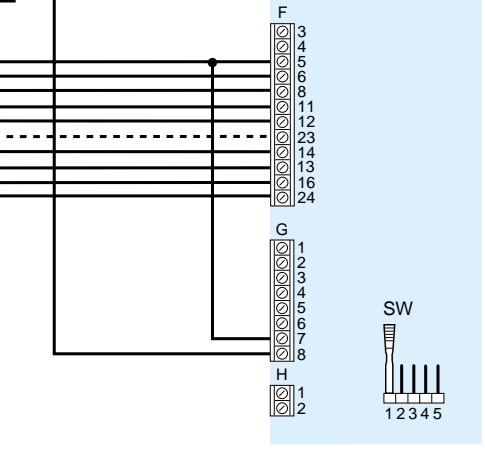
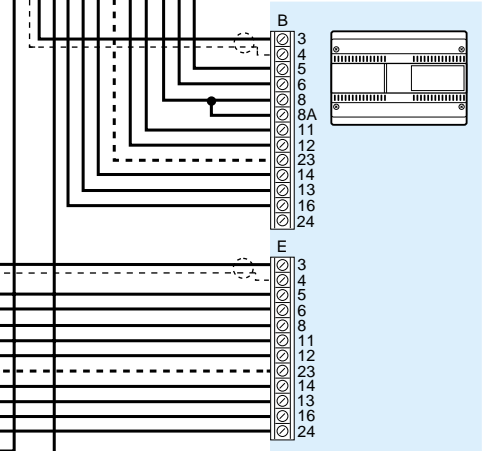
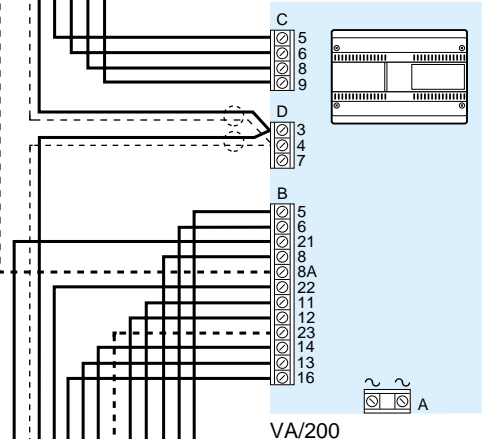
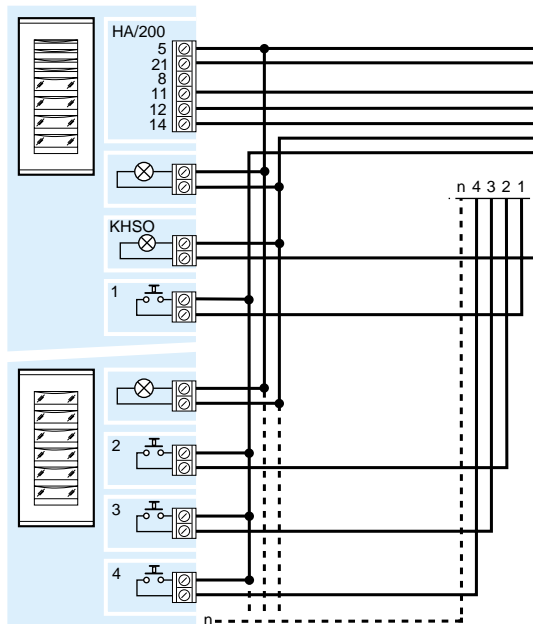

SE 8009.4

IMPIANTO MONO O PLURIFAMILIARE CON 2 INGRESSI (SEGNAZIONE D'INGRESSO OCCUPATO).

SINGLE OR MULTI-FLAT INSTALLATION USING 2 ENTRY PANELS (ENGAGED SIGNAL INDICATOR).

EIN- ODER MEHRFAMILIENHAUSANLAGE MIT 2 AUßENSTATIONEN UND BESETZTANZEIGE.

INSTALLATION POUR PAVILLON OU IMMEUBLE A 2 ENTREES (INDICATION DE LIGNE OCCUPEE).

EQUIPO MONO O MULTIFAMILIAR CON 2 ENTRADAS (SEÑALACION DE ENTRADA OCUPADA).

INSTALAÇÃO MONO O PLURIFAMILIAR COM 2 ENTRADAS (COM SINALIZAÇÃO DE CHAMADA OCUPADA).

SE 8009.4-A

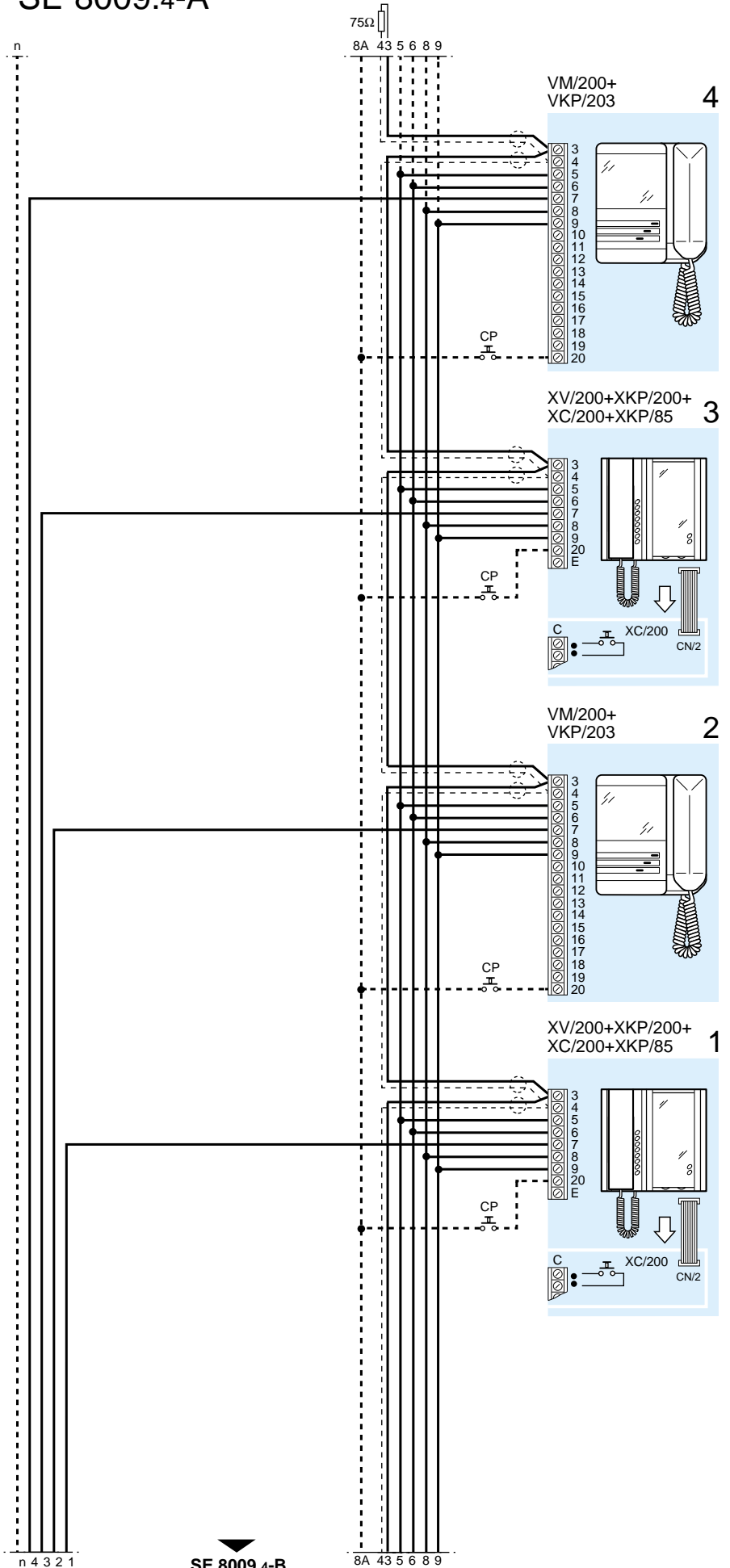

SE 8009.4-B

SE 8009.4-A

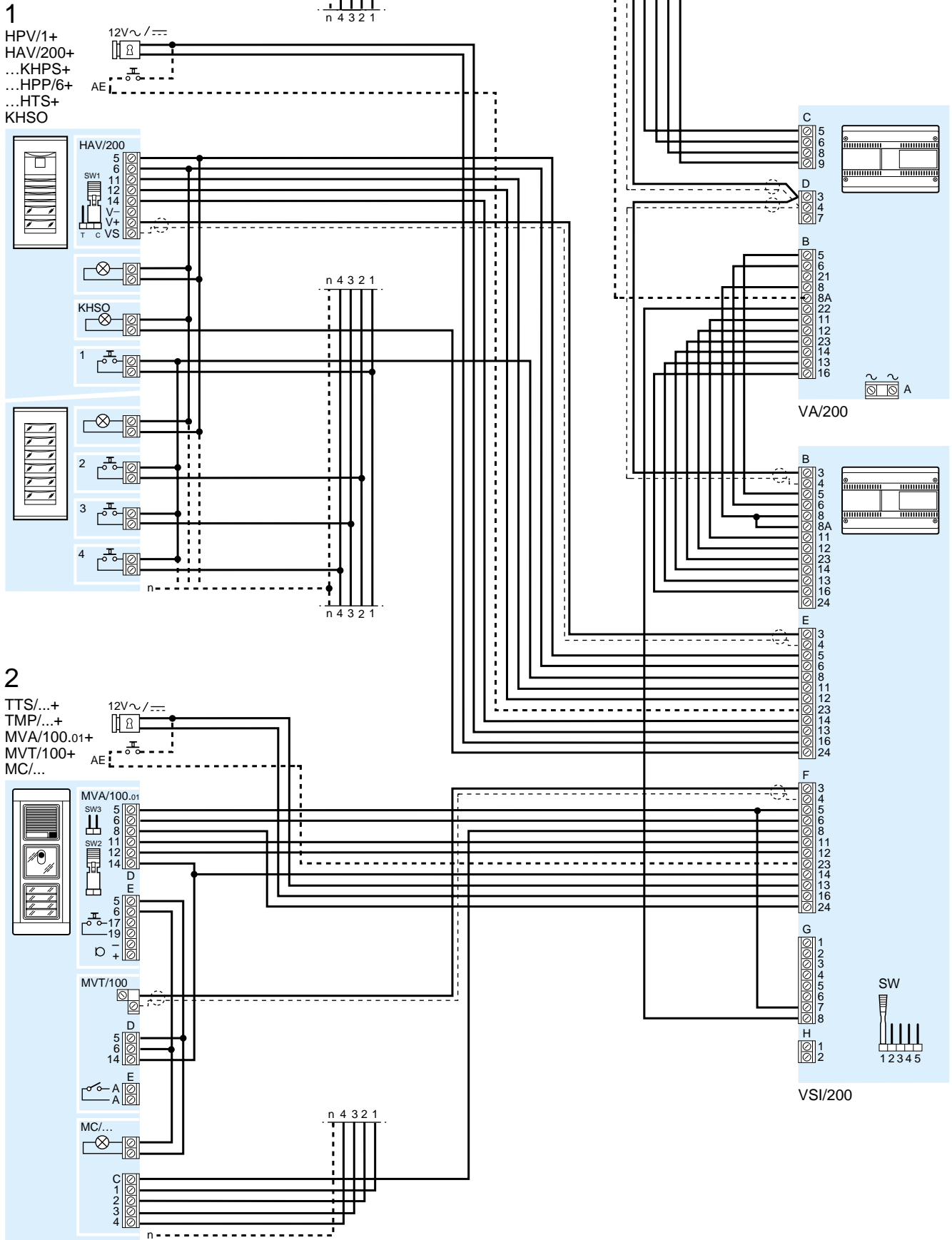

SE 8011.2

IMPIANTO MONO O PLURIFAMILIARE CON 3 INGRESSI (SEGNAZIONE D'INGRESSO OCCUPATO).

SINGLE OR MULTI-FLAT INSTALLATION USING 3 ENTRY PANELS (ENGAGED SIGNAL INDICATOR).

EIN- ODER MEHRFAMILIENHAUSANLAGE MIT 3 AUßENSTATIONEN UND BESETZTANZEIGE.

INSTALLATION POUR PAVILLON OU IMMEUBLE A 3 ENTREES (INDICATION DE LIGNE OCCUPEE).

EQUIPO MONO O MULTIFAMILIAR CON 3 ENTRADAS (SEÑALACION DE ENTRADA OCUPADA).

INSTALAÇÃO MONO O PLURIFAMILIAR COM 3 ENTRADAS (COM SINALIZAÇÃO DE CHAMADA OCUPADA).

IMPORTANTE. Togliere il ponticello SW1 nel selettore VSI/200 n.1.

IMPORTANT. Remove SW1 jumper from VSI/200 selector 1.

WICHTIG. Brücke SW1 am Wähler VSI/200 Nr.1 entfernen.

IMPORTANT. Enlever le cavalier SW1 du sélecteur VSI/200 n.1.

IMPORTANTE. Quitar el puente SW1 del selector VSI/200 n.1.

SE 8011.2-A

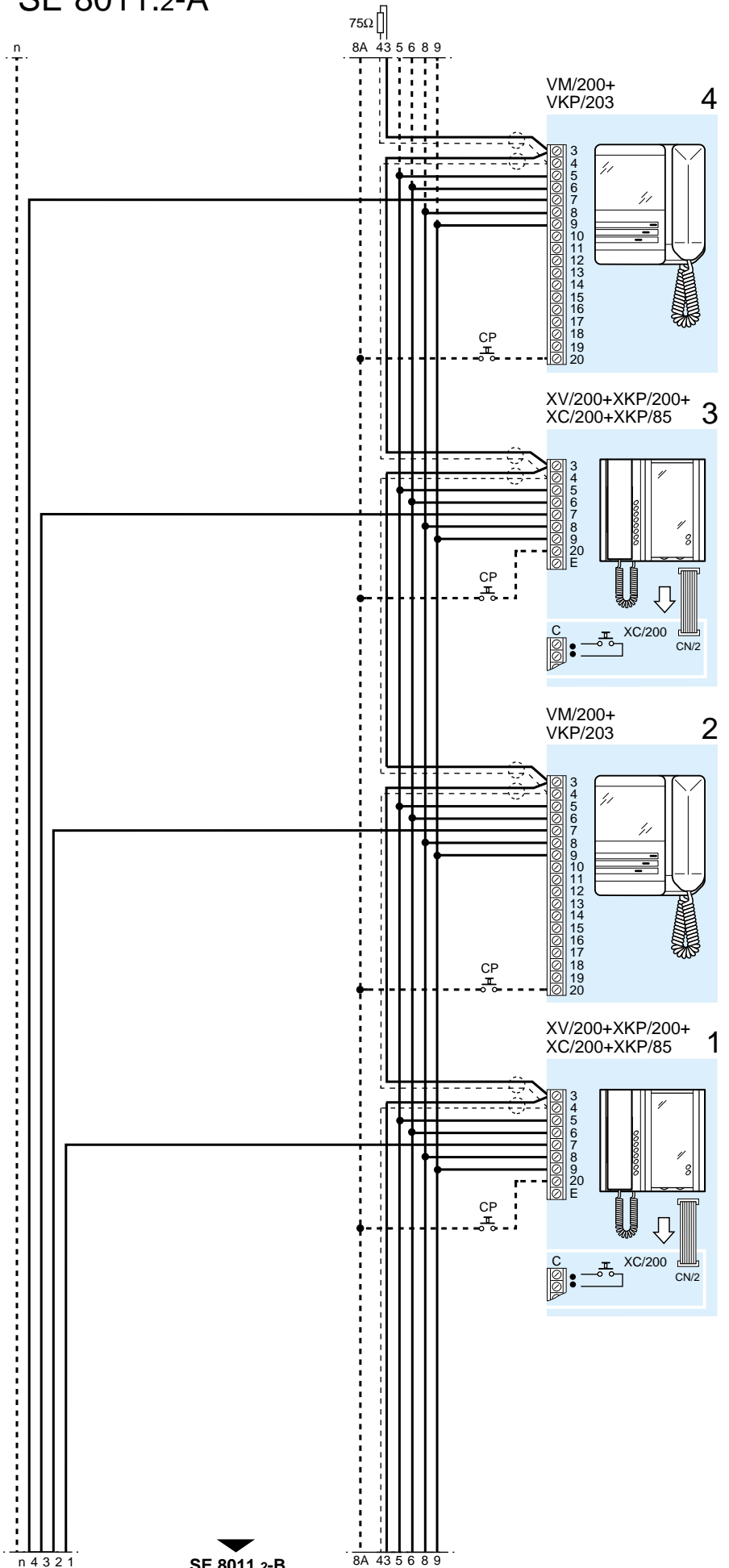

SE 8011.2-B

SE 8011.2-B

SE 8011.2-A

n 4 3 2 1

8A 4 3 5 6 8 9

n 4 3 2 1

1
 HPV/1+
 HAV/200+
 ...KHPS+
 ...HPP/6+
 ...HTS+
 KHSO

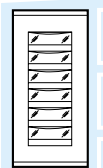
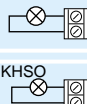
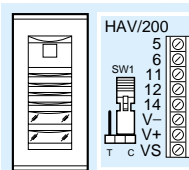
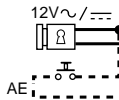

n 4 3 2 1

n 4 3 2 1

SE 8011.2-C

24 16 12 14 22 21 8 9 5 4 3 8C 5C 6C

1
 VSI/200

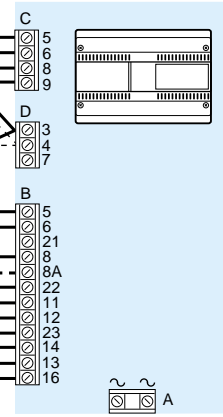

VA/200

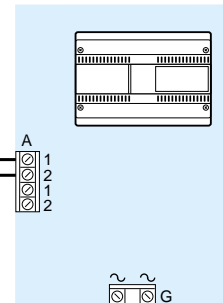

VAS/100

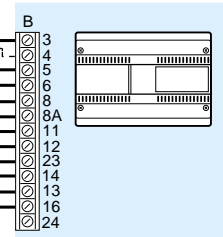

VSI/200



VSI/200

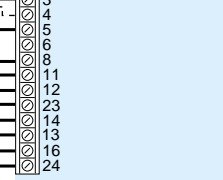

VSI/200

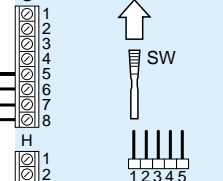

VSI/200



SE 8011.2-C

2

TTS/...+
 TMP/...+
 MVA/100.01+
 MVT/100+
 MC/...

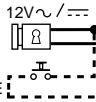
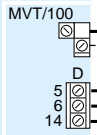
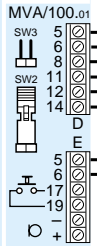

AE

n 4 3 2 1

n 4 3 2 1

n 4 3 2 1

n 4 3 2 1

SE 8011.2-B

24 19 18 14 13 12 11 8 6 5 4 3
 8G 5G 7 6G

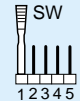
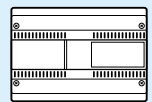
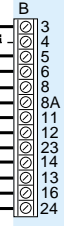

2

VSI/200

1

HPV/1+
 HAV/200+
 ...KHPS+
 ...HPP/6+
 ...HTS+
 KHISO

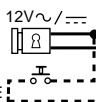
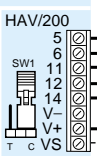
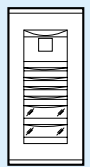

AE

n 4 3 2 1

n 4 3 2 1

SE 8010.3

IMPIANTO MONO O PLURIFAMILIARE CON 4 INGRESSI (SEGNAZIONE D'INGRESSO OCCUPATO).

SINGLE OR MULTI-FLAT INSTALLATION USING 4 ENTRY PANELS (ENGAGED SIGNAL INDICATOR).

EIN- ODER MEHRFAMILIENHAUSANLAGE MIT 4 AUßENSTATIONEN UND BESETZTANZEIGE.

INSTALLATION POUR PAVILLON OU IMMEUBLE A 4 ENTREES (INDICATION DE LIGNE OCCUPEE).

EQUIPO MONO O MULTIFAMILIAR CON 4 ENTRADAS (SEÑALACION DE ENTRADA OCUPADA).

INSTALAÇÃO MONO O PLURIFAMILIAR COM 4 ENTRADAS (COM SINALIZAÇÃO DE CHAMADA OCUPADA).

IMPORTANTE. Togliere il ponticello SW1 nei selettori VSI/200 n.1 e 2.

IMPORTANT. Remove SW1 jumper from VSI/200 selectors 1 and 2.

WICHTIG. Brücke SW1 am Wähler VSI/200 Nr.1 und 2 entfernen.

IMPORTANT. Enlever le cavalier SW1 du sélecteurs VSI/200 n.1 et 2.

IMPORTANTE. Quitar el puente SW1 de los selectores VSI/200 n.1 y 2.

SE 8010.3-A

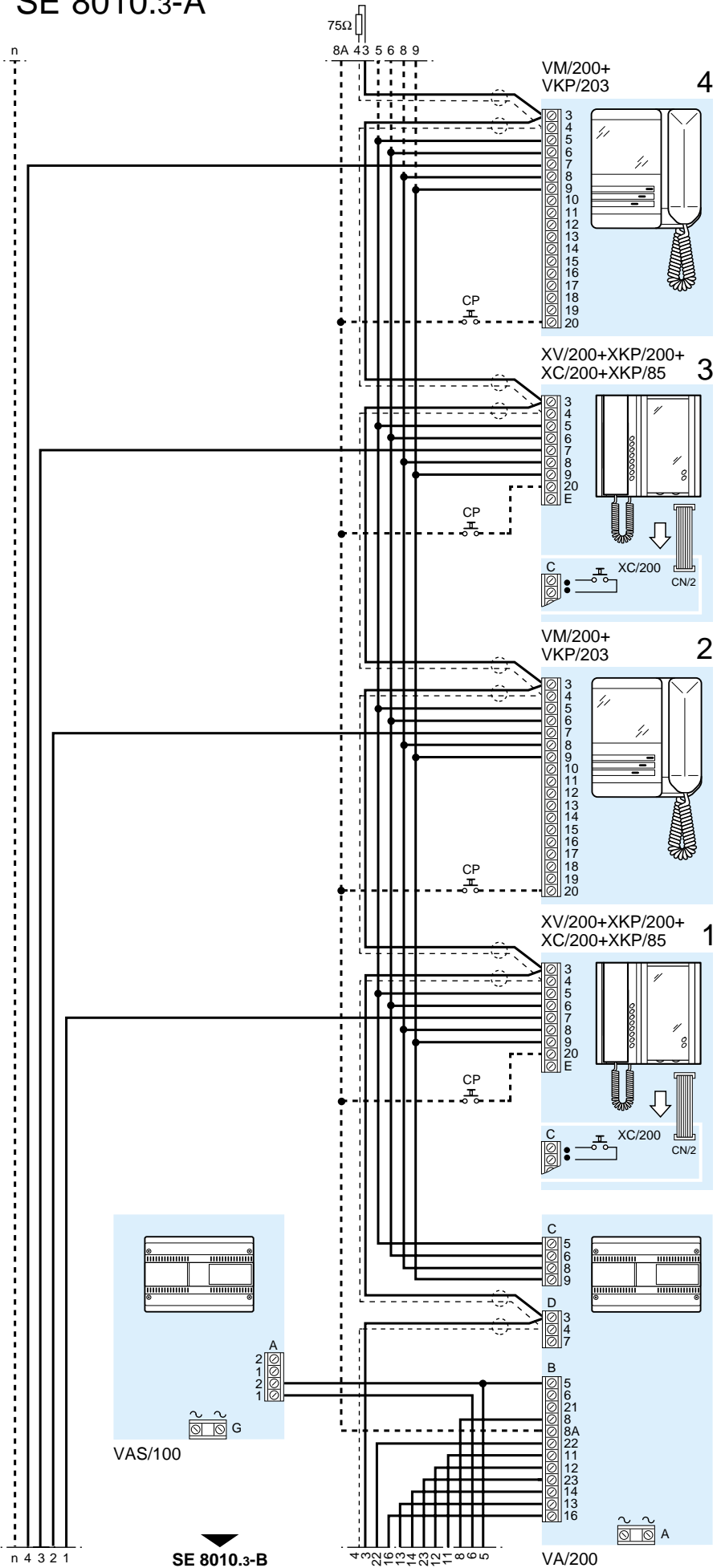

SE 8010.3-B

SE 8010.3-B

SE 8010.3-A

1
 HPV/1+
 HAV/200+
 ...KHPS+
 ...HPP/6+
 ...HTS+
 KHHSO

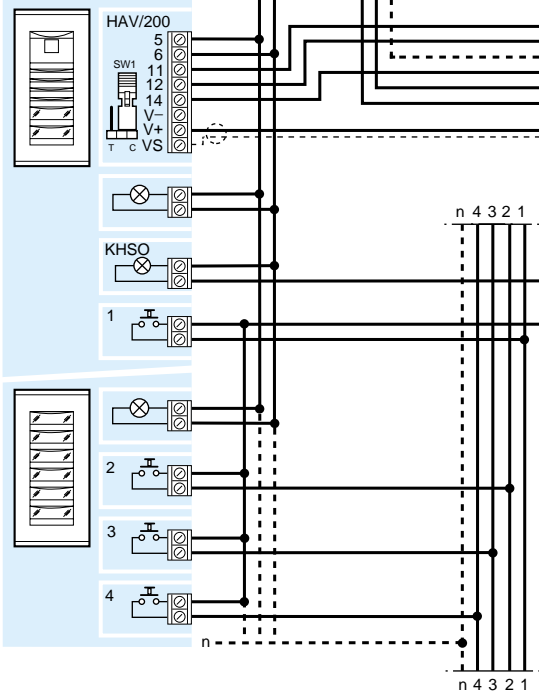

2
 TTS/...+
 TMP/...+
 MVA/100.01+
 MVT/100+
 MC/...

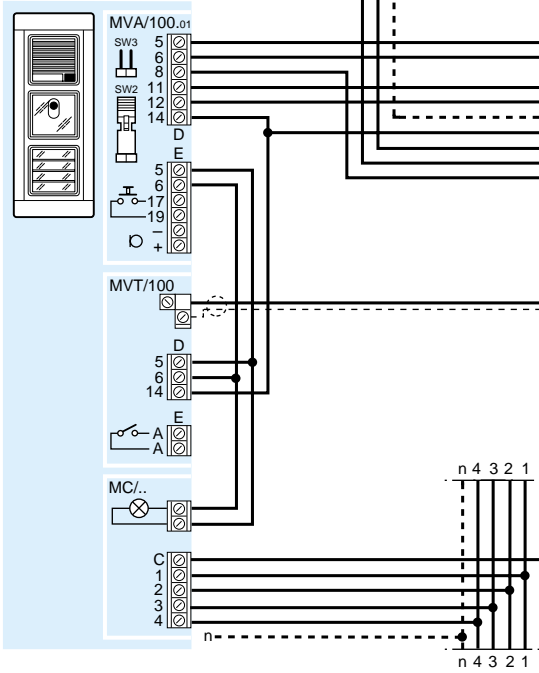

SE 8010.3-C

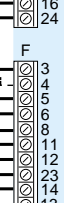
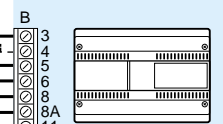
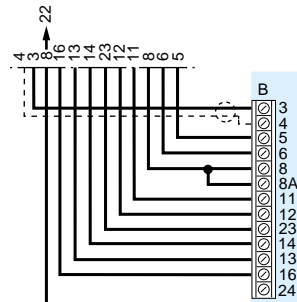

SE 8010.3-C

3

HPV/1+
HAV/200+
...KHPS+
...HPP/6+
...HTS+
KHSO

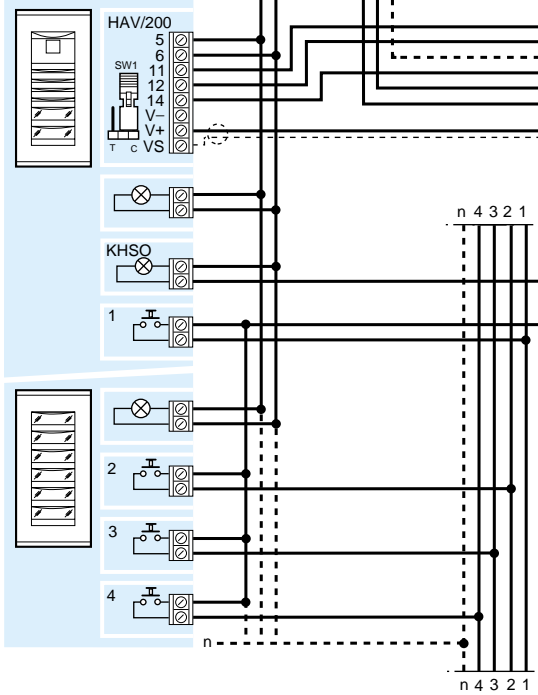

4

TTS/...+
TMP/...+
MVA/100.01+
MVT/100+
MC/...

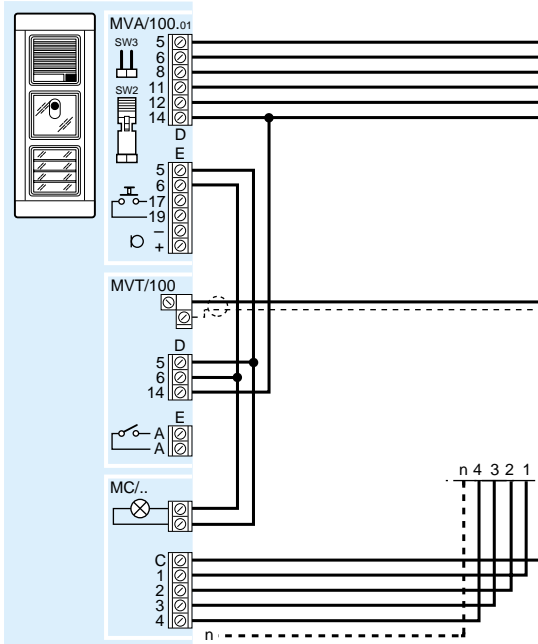

SE 8010.3-B

24 16 13 14 22 11 8 6 5 4 3 8G 5G 7 ← 6G

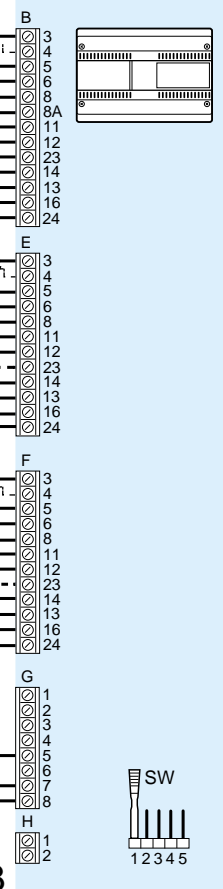

3

VSI/200

SE 8009.4X

IMPIANTO MONO O PLURIFAMILIARE CON 2 INGRESSI (SEGNAZIONE D'INGRESSO OCCUPATO).

SINGLE OR MULTI-FLAT INSTALLATION USING 2 ENTRY PANELS (ENGAGED SIGNAL INDICATOR).

EIN- ODER MEHRFAMILIENHAUSANLAGE MIT 2 AUßENSTATIONEN UND BESETZTANZEIGE.

INSTALLATION POUR PAVILLON OU IMMEUBLE A 2 ENTREES (INDICATION DE LIGNE OCCUPEE).

EQUIPO MONO O MULTIFAMILIAR CON 2 ENTRADAS (SEÑALACION DE ENTRADA OCUPADA).

INSTALAÇÃO MONO O PLURIFAMILIAR COM 2 ENTRADAS (COM SINALIZAÇÃO DE CHAMADA OCUPADA).

SE 8009.4X-A

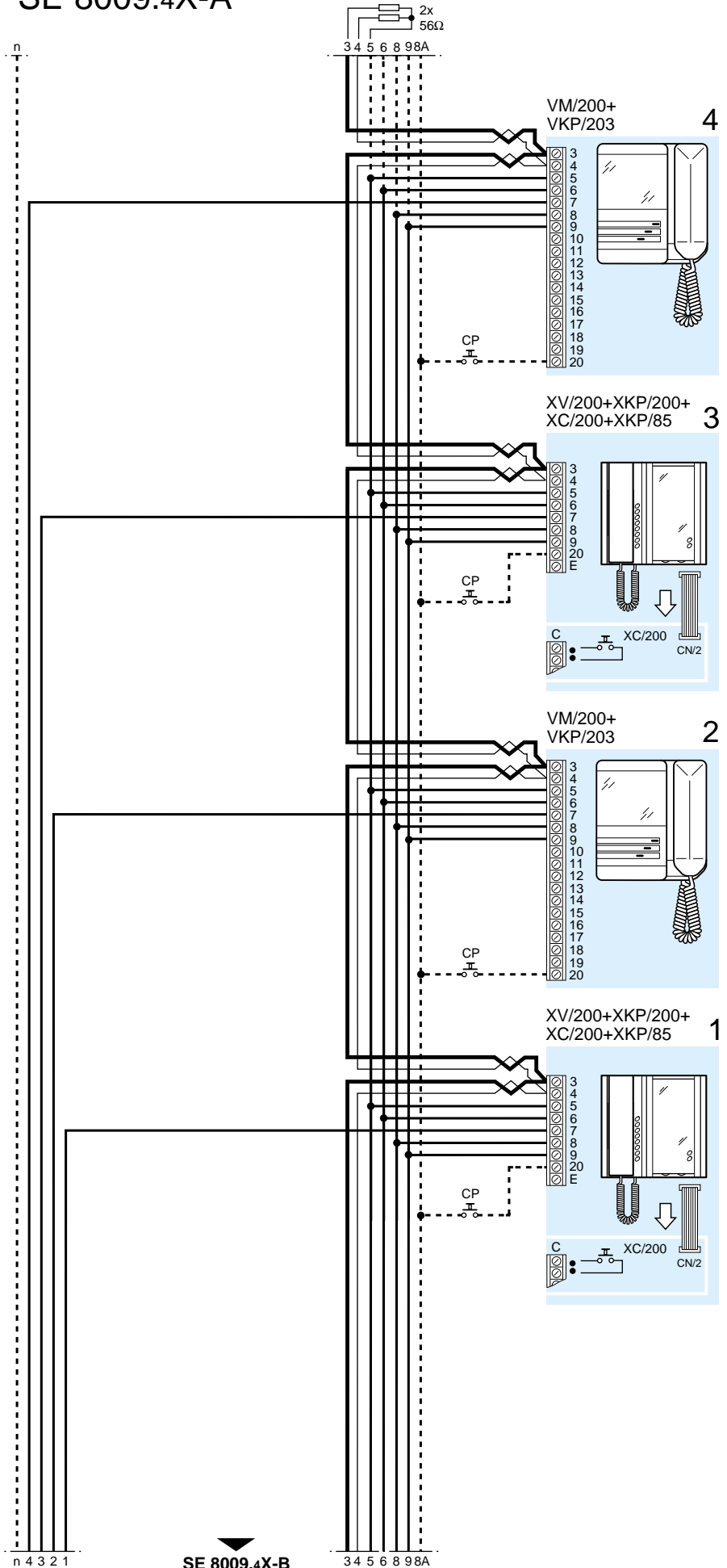

SE 8009.4X-B

SE 8009.4X-B

SE 8009.4X-A

1

HPV/1+
HAV/200+
...KHPs+
...HPP/6+
...HTS+
KHSO

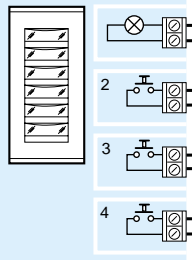
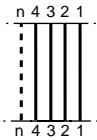
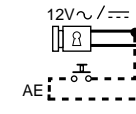
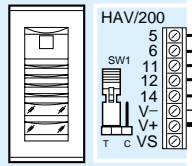

2

TTS/...+
TMP/...+
MVA/100.01+
MVT/100+
VTX/100+
MC/...

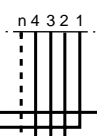
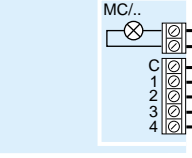
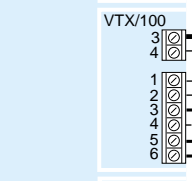
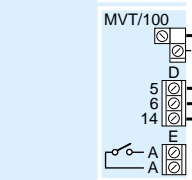
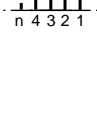
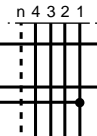
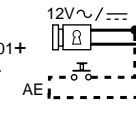
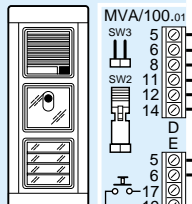

3 4 5 6 8 9 8A

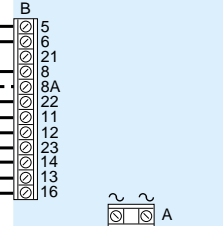
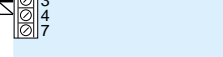
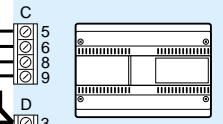

VA/200

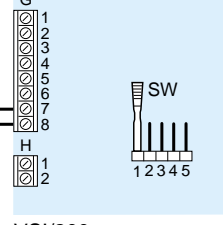
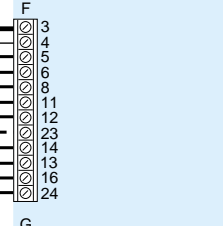
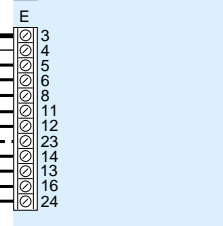
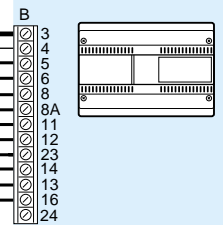

VSI/200

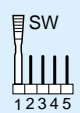

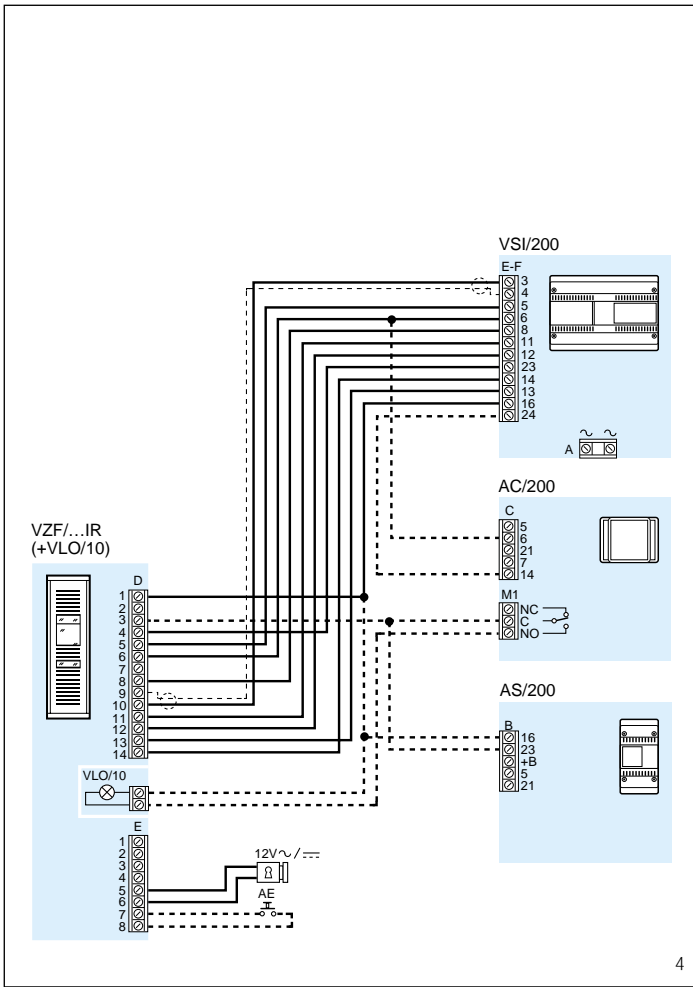

Fig.4 - Schema di collegamento tra il selettore d'ingresso VSI/200 ed il posto esterno VZF/...IR (trasmissione del segnale video tramite cavo coassiale).

Fig.4 - Connection diagram between VSI/200 entrance selector and VZF/...IR entry panel (video signal transmission by coaxial cable).

Abb.4 - Anschlüsse zwischen Eingangswähler VSI/200 und Außenstation VZF/...IR (Videosignal Übertragung mit Koaxialkabel).

Fig.4 - Schéma de raccordement entre sélecteur d'entrée VSI/200 et poste extérieur VZF/...IR (transmission du signal vidéo par câble coaxial).

Fig.4 - Esquema de conexión entre el selector de entrada VSI/200 y la placa exterior VZF/...IR (transmisión de la señal de video a través de un cable coaxial).

Fig.4 - Esquema de ligação entre o selector de entrada de video-porteiro VSI/200 e a placa botoneira serie VZF/...IR (distribuição do sinal video com cabo coaxial).

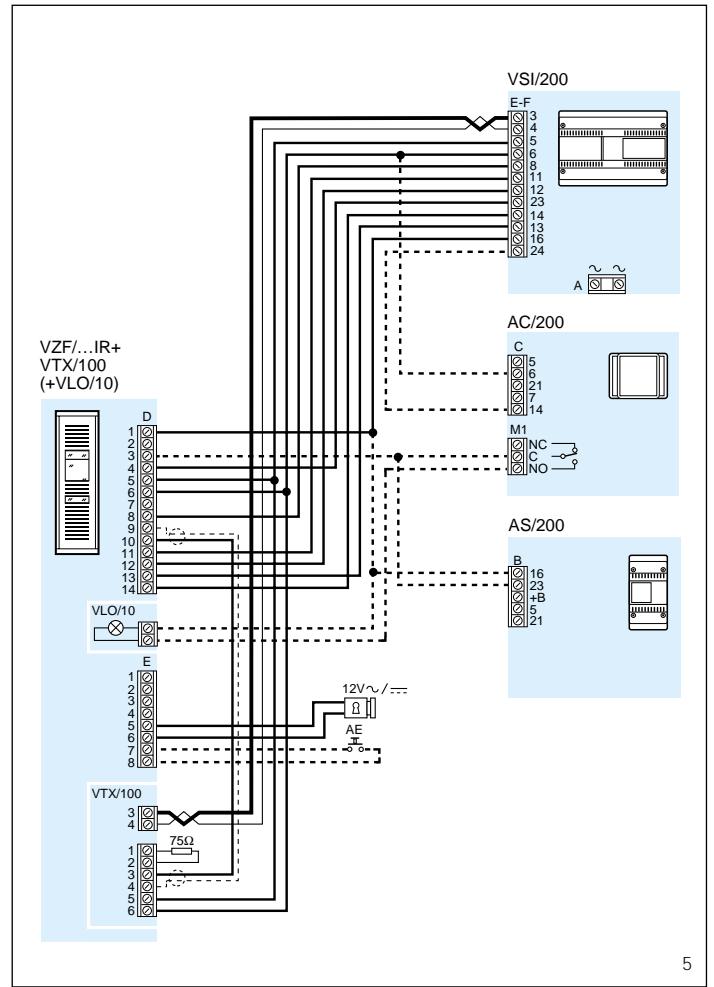

Fig.5 - Schema di collegamento tra il selettore d'ingresso VSI/200 ed il posto esterno VZF/...IR (trasmissione del segnale video tramite doppino telefonico).

Fig.5 - Connection diagram between VSI/200 entrance selector and VZF/...IR entry panel (video signal transmission by twisted pair).

Abb.5 - Anschlüsse zwischen Eingangswähler VSI/200 und Außenstation VZF/...IR (Videosignal Übertragung mit Telefonkabel).

Fig.5 - Schéma de raccordement entre sélecteur d'entrée VSI/200 et poste extérieur VZF/...IR (transmission du signal vidéo par paire torsadé).

Fig.5 - Esquema de conexión entre el selector de entrada VSI/200 y la placa exterior VZF/...IR (transmisión de la señal de video a través de un par telefónico trenzado).

Fig.5 - Esquema de ligação entre o selector de entrada de video-porteiro VSI/200 e a placa botoneira serie VZF/...IR (distribuição do sinal video com par TVHV).